

Linear Unit CTV 200

The CTV series describes linear units with a precision ball screw drive and two parallel, integrated, zero backlash rail guides. In the linear units CTV a precision ball screw, with tolerance class ISO7 (ISO5 on request), with reduced backlash of the ball nut is used.

Two parallel circulating antistatic polyurethane sealing strips and an aluminum cover are ensuring to protect all the parts in the profile from dust and other contaminations. Re-lubrication can be done through maintenance holes on the side of the profile.

Modulus of Elasticity: $E = 70000 \text{ N / mm}^2$

Operating Temperature (°C): 0 ~ +60 For operating temperature out of the presented range, please contact Rollco.

Duty Cycle: 100%

Max. Acceleration (m/s²): 20





1. Drive block with floating bearing
2. Gap-type seal of antistatic PU strip (recirculating)
3. Ball screw tolerance ISO7 (ISO5 available on request)
4. Carriage; with built in magnets
5. Aluminium cover
6. Aluminium profile - hard anodized
7. Two integrated linear ball guideways
8. Central lubrication port, both sides
9. End block with fixed bearing

Deflection of the linear unit

CTV 200

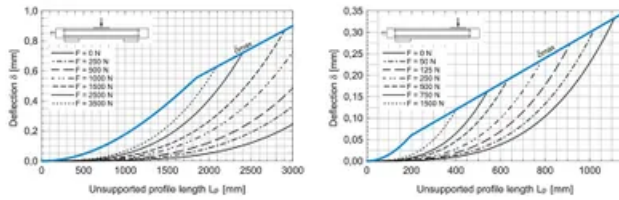

① The linear units do not include any safety stroke. Absolute stroke = Effective stroke + 2 x safety stroke.

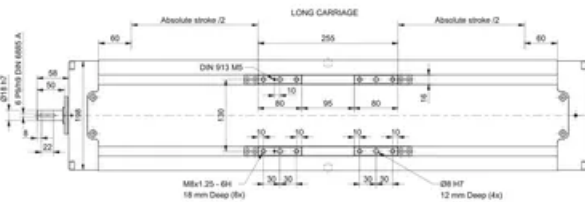

① Journal with or without keyway. ② All dimensions in mm. Drawings scales are not equal.

Deflection of the linear unit

CTV

Fixed - fixed mounting

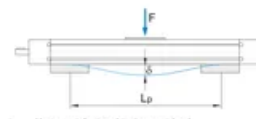

A Maximum deflection of the linear unit [mm]
 linear Maximum permissible deflection of the linear unit [mm]
 F Applied force [N]
 Lp Unsupported profile length [mm]

Fixed - free mounting

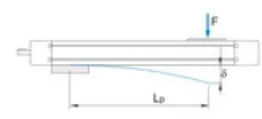

The maximum permissible deflection (linear) must not be exceeded. In the case that maximum deflection (delta) exceeds the maximum permissible deflection (linear additional profile supports are needed).

① The linear units do not include any safety stroke. Absolute stroke = Effective stroke + 2 x safety stroke.

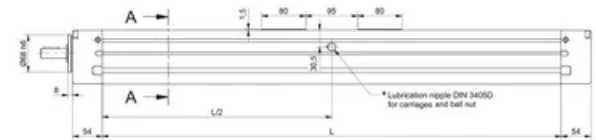

* Lubrication point position:
 Long carriage: L/2
 Short carriage: L/2 - 53 mm

① Journal with or without keyway. ② All dimensions in mm. Drawings scales are not equal.

① The linear units do not include any safety stroke. Absolute stroke = Effective stroke + 2 x safety stroke.

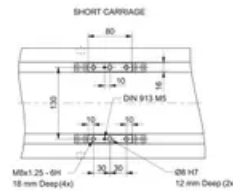

① Journal with or without keyway. ② All dimensions in mm. Drawings scales are not equal.

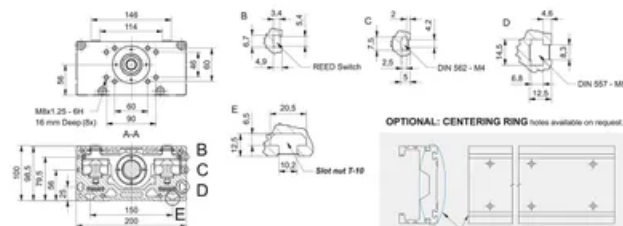

① Journal with or without keyway. ② All dimensions in mm. Drawings scales are not equal.

Defining of the linear unit length

$$L = \text{Effective stroke} + 2 \times \text{Safety stroke} + L_v + 120 \text{ mm}$$

$$L_{\text{total}} = L + 100 \text{ mm}$$

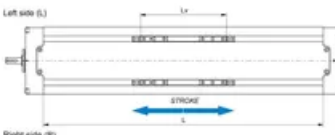

Lv - Long carriage = 255 mm
 Lv - Short carriage = 80 mm

$$L = \text{Effective stroke} + 2 \times \text{Safety stroke} + A + 200 \text{ mm}$$

$$L_{\text{total}} = L + 100 \text{ mm}$$

A ≥ 130 mm
 A ≥ 105 mm

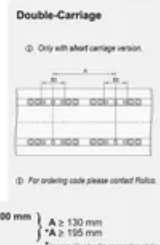

Connection plate

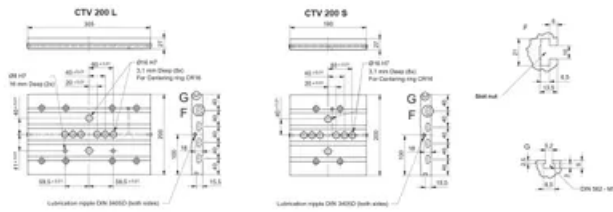

Mounting the drive

- by the MOTOR SIDE DRIVE - MSD
- by the MOTOR ADAPTER WITH COUPLING

Linear Unit	Plate length (mm)	Weight (kg)	Code
CTV 200 S	100	2.32	80000
CTV 200 L	300	3.75	80007

Mounting elements for mounting the connector plate on the linear unit are included.

Maximum travel speed as a function of the profile length (vmax - L curves)

CTV 200

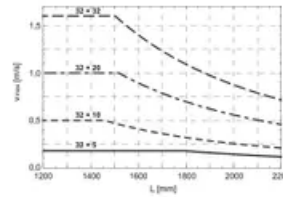

General data

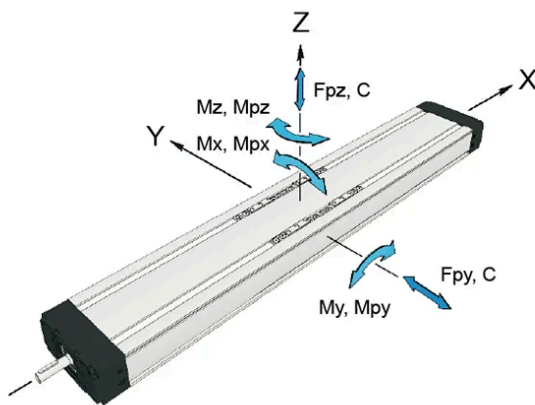

For length/stroke over the stated value, please contact Rollco. Values for max. stroke are not valid for double carriage (equation of defining the linear unit length for particular size of the linear unit needs to be used).

Recommended values of loads

All the data of static and dynamic moments and load capacities stated are theoretical without considering any safety factor. The safety factor depends on the application and its requested safety. We recommend a minimum safety factor ($f_s=5.0$).

Designation	Carriage Length L_v (mm)	Dynamic Moment M_x (Nm)	Dynamic Moment M_y (Nm)	Dynamic Moment M_z (Nm)	Dynamic Load Capacity C (N)
CTV 200 S - 32 x 5	80	3220	450	900	49600
CTV 200 S - 32 x 10	80	3220	450	900	49600
CTV 200 S - 32 x 20	80	3220	450	900	49600
CTV 200 S - 32 x 32	80	3220	450	900	49600
CTV 200 L - 32 x 5	255	6445	8680	8680	99200
CTV 200 L - 32 x 10	255	6445	8680	8680	99200
CTV 200 L - 32 x 20	255	6445	8680	8680	99200
CTV 200 L - 32 x 32	255	6445	8680	8680	99200

Designation	Static Load Capacity C_0 (N)	Max. Permissible Loads Forces F_{py} (N)	Max. Permissible Loads Forces F_{pz} (N)	Max. Permissible Loads Moments M_{px} (Nm)	Max. Permissible Loads Moments M_{py} (Nm)	Max. Permissible Loads Moments M_{pz} (Nm)
CTV 200 S - 32 x 5	85000	10000	24610	1600	450	308
CTV 200 S - 32 x 10	85000	10000	24610	1600	450	308
CTV 200 S - 32 x 20	85000	10000	24610	1600	450	308
CTV 200 S - 32 x 32	85000	10000	24610	1600	450	308
CTV 200 L - 32 x 5	170000	20000	51540	3350	4550	1750
CTV 200 L - 32 x 10	170000	20000	51540	3350	4550	1750
CTV 200 L - 32 x 20	170000	20000	51540	3350	4550	1750
CTV 200 L - 32 x 32	170000	20000	51540	3350	4550	1750

Designation	Moved Mass (kg)	Max. Length Lmax (mm)	Max. Stroke (mm)	Min. Stroke (mm)
CTV 200 S - 32 x 5	3.11	2200	2000	65
CTV 200 S - 32 x 10	3.11	2200	2000	65
CTV 200 S - 32 x 20	3.11	2200	2000	65
CTV 200 S - 32 x 32	3.11	2200	2000	70
CTV 200 L - 32 x 5	6.21	2200	1825	65
CTV 200 L - 32 x 10	6.21	2200	1825	65
CTV 200 L - 32 x 20	6.21	2200	1825	65
CTV 200 L - 32 x 32	6.21	2200	1825	70

General data double carriage

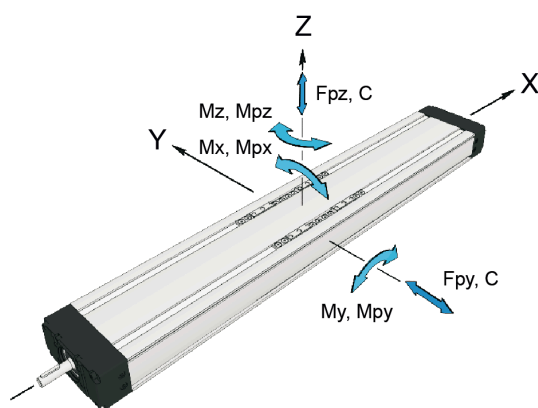

Mass calculation does not include mass of motor, reduction gear, switches and clamps.

Abs. stroke	Absolute stroke [mm]
A	Distance between carriages [mm]
nc	Number of carriages

Designation	Carriage version	Dynamic Load Capacity C (N)	Static Load Capacity C0 (N)	Dynamic Moment Mx (Nm)	Dynamic Moment My (Nm)
CTV 200 S - 32 x 5	S2 (S)	99200	170000	6440	49.6 × A (mm)
CTV 200 S - 32 x 10	S2 (S)	99200	170000	6440	49.6 × A (mm)
CTV 200 S - 32 x 20	S2 (S)	99200	170000	6440	49.6 × A (mm)
CTV 200 S - 32 x 32	S2 (S)	99200	170000	6440	49.6 × A (mm)
CTV 200 L - 32 x 5	S2 (L)	99200	170000	6440	49.6 × A (mm)
CTV 200 L - 32 x 10	S2 (L)	99200	170000	6440	49.6 × A (mm)
CTV 200 L - 32 x 20	S2 (L)	99200	170000	6440	49.6 × A (mm)
CTV 200 L - 32 x 32	S2 (L)	99200	170000	6440	49.6 × A (mm)

Designation	Dynamic Moment Mz (Nm)	Max. Permissible Loads Forces Fpy (N)	Max. Permissible Loads Forces Fpz (N)	Max. Permissible Loads Moments Mpx (Nm)	Max. Permissible Loads Moments Mpy (Nm)	Max. Permissible Loads Moments Mpz (Nm)
CTV 200 S - 32 x 5	49.6 × A (mm)	20000	49230	3200	24.6 × A (mm)	10.0 × A (mm)
CTV 200 S - 32 x 10	49.6 × A (mm)	20000	49230	3200	24.6 × A (mm)	10.0 × A (mm)
CTV 200 S - 32 x 20	49.6 × A (mm)	20000	49230	3200	24.6 × A (mm)	10.0 × A (mm)
CTV 200 S - 32 x 32	49.6 × A (mm)	20000	49230	3200	24.6 × A (mm)	10.0 × A (mm)
CTV 200 L - 32 x 5	49.6 × A (mm)	20000	49230	3200	24.6 × A (mm)	10.0 × A (mm)
CTV 200 L - 32 x 10	49.6 × A (mm)	20000	49230	3200	24.6 × A (mm)	10.0 × A (mm)

Designation	Dynamic Moment Mz (Nm)	Max. Permissible Loads Forces Fpy (N)	Max. Permissible Loads Forces Fpz (N)	Max. Permissible Loads Moments Mpx (Nm)	Max. Permissible Loads Moments Mpy (Nm)	Max. Permissible Loads Moments Mpz (Nm)
CTV 200 L - 32 x 20	$49.6 \times A$ (mm)	20000	49230	3200	$24.6 \times A$ (mm)	$10.0 \times A$ (mm)
CTV 200 L - 32 x 32	$49.6 \times A$ (mm)	20000	49230	3200	$24.6 \times A$ (mm)	$10.0 \times A$ (mm)

Drive data

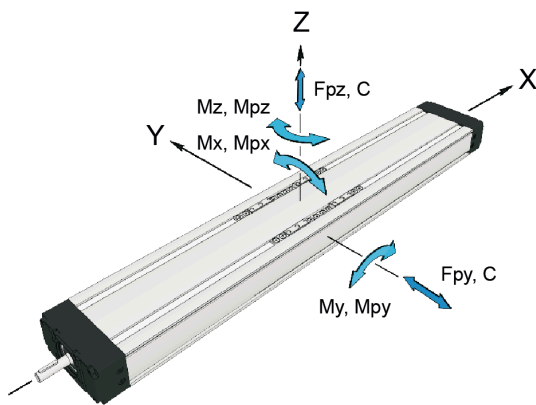

Max. travel speed depends of the length of the linear unit, see diagram for particular size of the linear unit. For travel speed over the stated value, please contact Rollco.

The stated values are for strokes up to 500 mm. No load torque value increases with stroke elongation.

For the ball nut with the preload of 2%, please contact Rollco.

For minimum stroke below the stated value, please contact Rollco.

Max. acceleration (m/s²): 20

For acceleration over the stated value, please contact Rollco.

Reduced effective diameter at journal with keyway decreases values of max. drive torque. See Max. Drive torque values in table below.

nc = Number of carriages

Designation	Max. Travel Speed (m/s)	Max. Rotational Speed (rev/min)	Max. Drive Torque Ma (Nm)	Lead Constant (mm/rev)	No Load Torque Carriage S (Nm)
CTV 200 S - 32 x 5	0.18	2150	16,7 (w. keyway), 16,7 (w.o keyway)	5	$0.60 \times nc$
CTV 200 S - 32 x 10	0.5	3000	27,3 (w. keyway), 52,3 (w.o keyway)	10	$0.70 \times nc$
CTV 200 S - 32 x 20	1	3000	27,3 (w. keyway), 52,3 (w.o keyway)	20	$0.75 \times nc$
CTV 200 S - 32 x 32	1.6	3000	27,3 (w. keyway), 52,3 (w.o keyway)	32	$0.80 \times nc$
CTV 200 L - 32 x 5	0.18	2150	16,7 (w. keyway), 16,7 (w.o keyway)	5	$0.60 \times nc$
CTV 200 L - 32 x 10	0.5	3000	27,3 (w. keyway), 52,3 (w.o keyway)	10	$0.70 \times nc$
CTV 200 L - 32 x 20	1	3000	27,3 (w. keyway), 52,3 (w.o keyway)	20	$0.75 \times nc$
CTV 200 L - 32 x 32	1.6	3000	27,3 (w. keyway), 52,3 (w.o keyway)	32	$0.80 \times nc$

Designation	No Load Torque Carriage L (Nm)	Ball Screw (d x l)	Max. Repeatability Precision Standard ISO7	Max. Repeatability Precision ISO5	Dynamic Load Capacity BS Ca (N)	Max. Axial Load Fx (N)
CTV 200 S - 32 x 5	$0.70 \times nc$	32 x 5	± 0.02	± 0.01	18850	18850
CTV 200 S - 32 x 10	$0.80 \times nc$	32 x 10	± 0.02	± 0.01	33400	29600
CTV 200 S - 32 x 20	$0.85 \times nc$	32 x 20	± 0.02	± 0.01	29700	14800
CTV 200 S - 32 x 32	$0.90 \times nc$	32 x 32	± 0.02	± 0.01	35150	9240
CTV 200 L - 32 x 5	$0.70 \times nc$	32 x 5	± 0.02	± 0.01	18850	18850
CTV 200 L - 32 x 10	$0.80 \times nc$	32 x 10	± 0.02	± 0.01	33400	29600
CTV 200 L - 32 x 20	$0.85 \times nc$	32 x 20	± 0.02	± 0.01	29700	14800

Designation	No Load Torque Carriage L (Nm)	Ball Screw (d x l)	Max. Repeatability Precision Standard ISO7	Max. Repeatability Precision ISO5	Dynamic Load Capacity BS Ca (N)	Max. Axial Load Fx (N)
CTV 200 L - 32 x 32	0.90 × nc	32 × 32	± 0.02	± 0.01	35150	9240

Designation	Planar Moment of Inertia Iy (cm ⁴)	Planar Moment of Inertia Iz (cm ⁴)
CTV 200 S - 32 x 5	417.4	3007.3
CTV 200 S - 32 x 10	417.4	3007.3
CTV 200 S - 32 x 20	417.4	3007.3
CTV 200 S - 32 x 32	417.4	3007.3
CTV 200 L - 32 x 5	417.4	3007.3
CTV 200 L - 32 x 10	417.4	3007.3
CTV 200 L - 32 x 20	417.4	3007.3
CTV 200 L - 32 x 32	417.4	3007.3

Mass and Mass moment

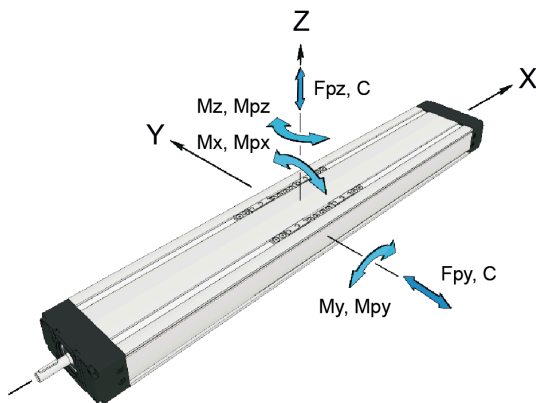

Mass calculation does not include mass of motor, reduction gear, switches and clamps.

Abs. stroke	Absolute stroke [mm]
A	Distance between carriages [mm]
nc	Number of carriages

Designation	Ball Screw (d x l)	Mass of Linear Unit (kg)	Mass Moment of Inertia (10 ⁻⁶ kg m ²)	Planar Moment of Inertia Iy (cm ⁴)	Planar Moment of Inertia Iz (cm ⁴)
CTV 200 S - 32 x 5	32 × 5	15.4 + 0.031 × (Abs. Stroke + (nc - 1) × A) + 3.11 × (nc - 1)	21.17 + 0.069 × (Abs. Stroke + (nc - 1) × A) + 0.20 × (nc - 1)	417.4	3007.3
CTV 200 S - 32 x 10	32 × 10	15.4 + 0.031 × (Abs. Stroke + (nc - 1) × A) + 3.11 × (nc - 1)	21.76 + 0.069 × (Abs. Stroke + (nc - 1) × A) + 0.79 × (nc - 1)	417.4	3007.3
CTV 200 S - 32 x 20	32 × 20	15.4 + 0.031 × (Abs. Stroke + (nc - 1) × A) + 3.11 × (nc - 1)	24.12 + 0.069 × (Abs. Stroke + (nc - 1) × A) + 3.15 × (nc - 1)	417.4	3007.3
CTV 200 S - 32 x 32	32 × 32	15.4 + 0.031 × (Abs. Stroke + (nc - 1) × A) + 3.11 × (nc - 1)	29.04 + 0.069 × (Abs. Stroke + (nc - 1) × A) + 8.07 × (nc - 1)	417.4	3007.3
CTV 200 L - 32 x 5	32 × 5	23.8 + 0.031 × (Abs. Stroke + (nc - 1) × A) + 6.21 × (nc - 1)	33.41 + 0.069 × (Abs. Stroke + (nc - 1) × A) + 0.39 × (nc - 1)	417.4	3007.3
CTV 200 L - 32 x 10	32 × 10	23.8 + 0.031 × (Abs. Stroke + (nc - 1) × A) + 6.21 × (nc - 1)	34.59 + 0.069 × (Abs. Stroke + (nc - 1) × A) + 1.59 × (nc - 1)	417.4	3007.3
CTV 200 L - 32 x 20	32 × 20	23.8 + 0.031 × (Abs. Stroke + (nc - 1) × A) + 6.21 × (nc - 1)	39.31 + 0.069 × (Abs. Stroke + (nc - 1) × A) + 6.29 × (nc - 1)	417.4	3007.3

Designation	Ball Screw (d x l)	Mass of Linear Unit (kg)	Mass Moment of Inertia (10 ⁻⁵ kg m ²)	Planar Moment of Inertia I _y (cm ⁴)	Planar Moment of Inertia I _z (cm ⁴)
CTV 200 L - 32 x 32	32 x 32	$23.8 + 0.031 \times (\text{Abs. Stroke} + (\text{nc} - 1) \times A) + 6.21 \times (\text{nc} - 1)$	$49.12 + 0.069 \times (\text{Abs. Stroke} + (\text{nc} - 1) \times A) + 16.11 \times (\text{nc} - 1)$	417.4	3007.3

Designation	Moved Mass (kg)
CTV 200 S - 32 x 5	3.11
CTV 200 S - 32 x 10	3.11
CTV 200 S - 32 x 20	3.11
CTV 200 S - 32 x 32	3.11
CTV 200 L - 32 x 5	6.21
CTV 200 L - 32 x 10	6.21
CTV 200 L - 32 x 20	6.21
CTV 200 L - 32 x 32	6.21