

Guiding unit GUC

Dimensions in mm.

Mounting (on the MCE profile) screws and nuts are included. Guiding unit GUC requires a female thread on the piston rod end.

Material: Body and plate in anodized aluminium. Guides in hardened steel.

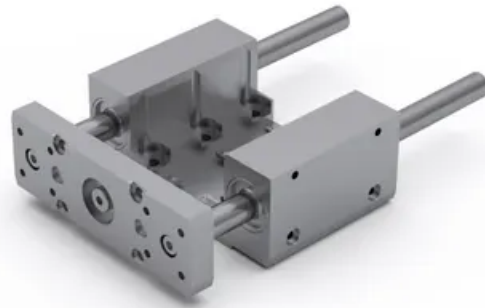

Displacement (friction) force

Designation	Displacement force [N] GUC with ball bushes
GUC 25	3
GUC 32	3
GUC 45	3

General Data

Maximum lateral loading (in y and z directions) as a function of a load position

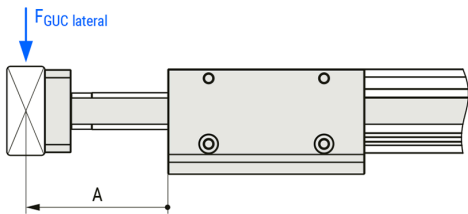
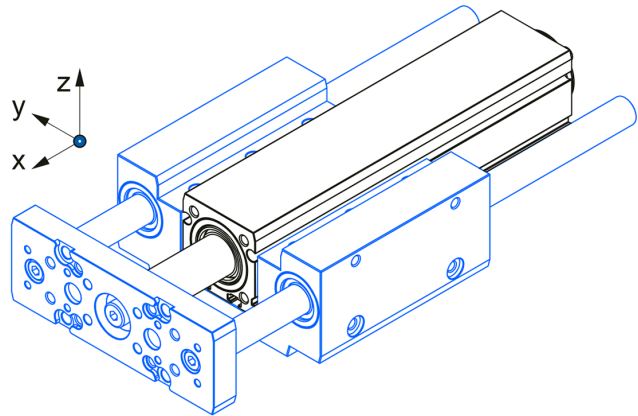
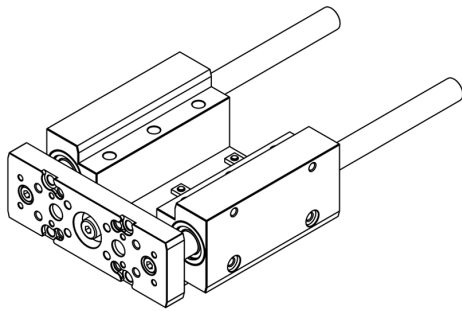

Moved mass of GUC is already considered in the equation for calculating the mass of GUC m_{GUC}

Abs. stroke	Absolute stroke [mm]
E	Extended piston rod [mm]

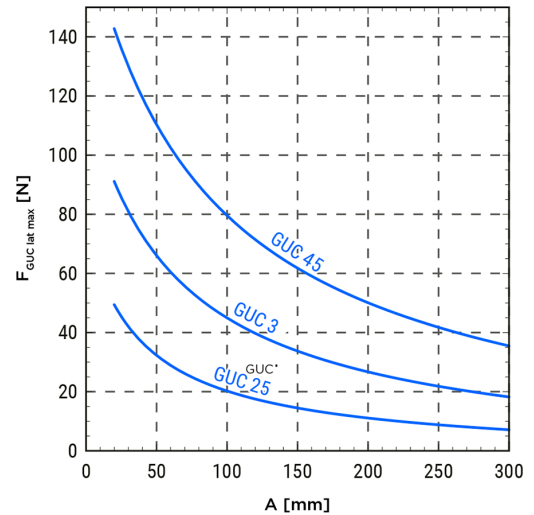

Designation	Compatible with	Mass of GUC m_{GUC} (kg)	Moved Mass of GUC m_{mGUC} (kg)	T1 (Nm)	T2 (Nm)
GUC 25	MCE 25	$0.30 + 0.0008 \times (\text{Abs. stroke} + E)$	$0.10 + 0.0008 \times (\text{Abs. stroke} + E)$	2.8	0.3
GUC 32	MCE 32	$0.65 + 0.0013 \times (\text{Abs. stroke} + E)$	$0.20 + 0.0013 \times (\text{Abs. stroke} + E)$	5.6	1.2
GUC 45	MCE 45	$1.30 + 0.0018 \times (\text{Abs. stroke} + E)$	$0.42 + 0.0018 \times (\text{Abs. stroke} + E)$	9.6	2.2

Dimensions

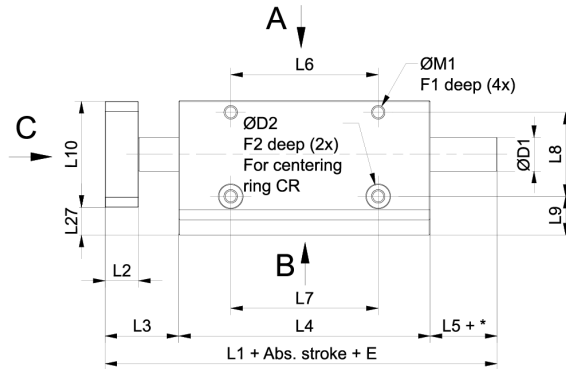
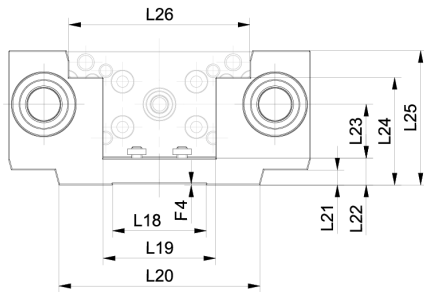

A (GUC 25)

A (GUC 32, 45)

* ... + Abs. stroke + E
 ** MCE mounting nuts and screws (6x)

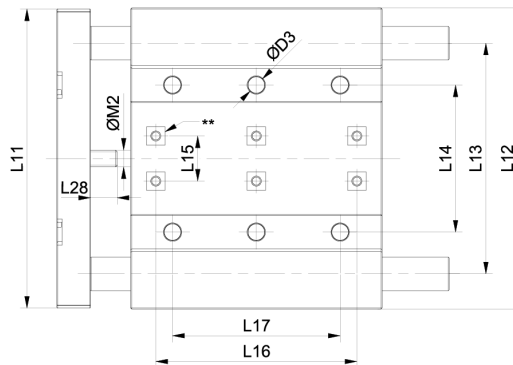
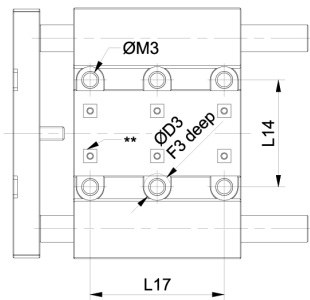

B (GUC 25)

B (GUC 32)

B (GUC 45)

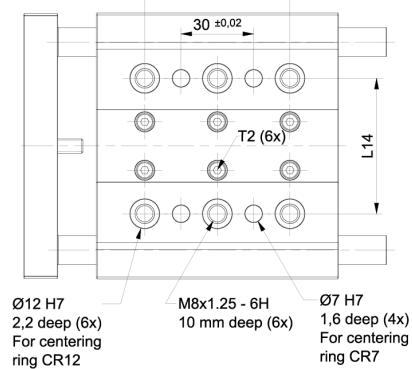
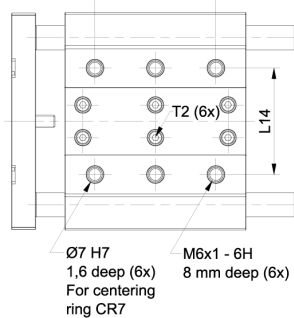
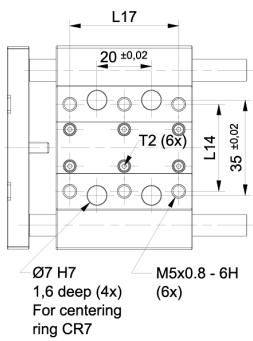

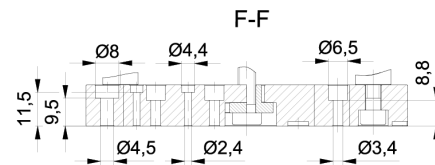
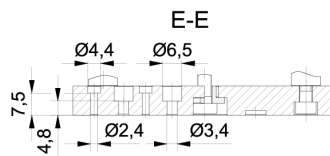
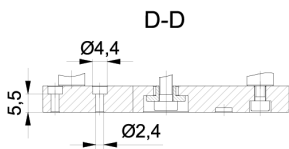
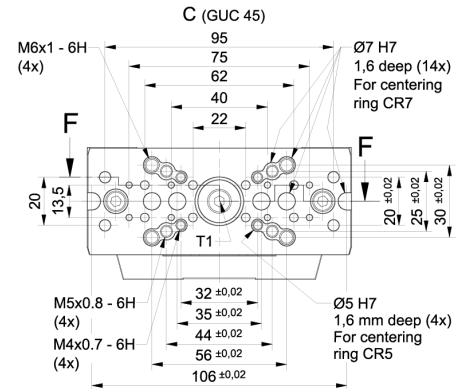
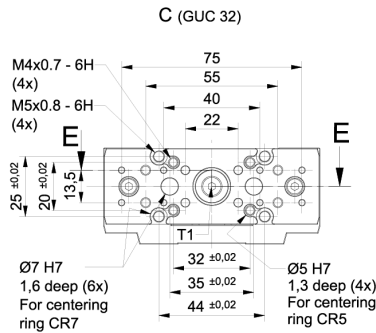
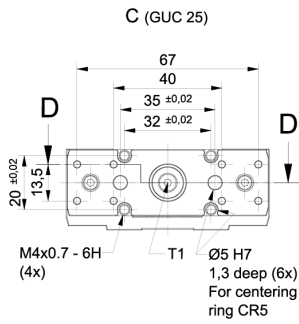

Designation	L1	L2	L3	L4	L5	L6	L7	L8	L9
GUC 25	88	8	18	50	20	32	32 (±0.02)	20	7.5
GUC 32	117	10	22	75	20	44	44 (±0.02)	25	11.5
GUC 45	150	14	30	100	20	56	56 (±0.02)	30	17.5

Designation	L10	L11	L12	L13	L14	L15	L16	L17	L18	L19
GUC 25	24.5	74.5	75	57	32	13.5	40	40	19	25.5
GUC 32	31.5	89.5	90	69	44 (±0.02)	13.5	60	50 (±0.02)	28	33.5
GUC 45	44.5	109.5	110	86	56 (±0.02)	20	60	60 (±0.02)	38	46.5

Designation	L20	L21	L22	L23	L24	L25	L26	L27	L28	D1
GUC 25	45	1.5	5	12.5	12.5	30	39	5.25	7.3	8
GUC 32	60	4.5	8	16	32	40	54	8.25	8	10
GUC 45	80	10.5	10	22.5	47	55	67	10.25	10.5	12

Designation	D2	D3	M1	M2	M3	F1	F2	F3	F4
GUC 25	5 (H7)	8	M3	M4	M5	12	1.3	4.5	0.3
GUC 32	7 (H7)	5.1	M4	M5	-	12	1.6	-	0.3
GUC 45	7 (H7)	6.6	M5	M6	-	12	1.6	-	0.3