

Linear Unit MTJ ECO 40

The MTJ ECO series linear unit is a powerful and cost-effective linear unit with toothed belt drive and a zero-backlash ball rail guide system for easy and accurate linear movements.

The linear unit MTJ ECO uses a pre-tensioned steel reinforced AT polyurethane timing toothed belt. In conjunction with a zero-backlash drive pulley high moments with alternating loads with good positioning accuracy, low wear and low noise can be realized.

Modulus of Elasticity: $E = 70000 \text{ N/mm}^2$

Operating Temperature (°C): $0 \sim +60$ For operating temperature out of the presented range, please contact Rollco.

Duty Cycle: 100%

Max. Acceleration (m/s²): 70

Max. Travel Speed (m/s): 3

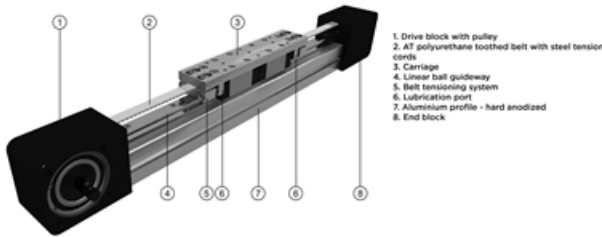

Deflection of the linear unit

MTJ ECO 40



Deflection of the linear unit

MTJ ECO 40

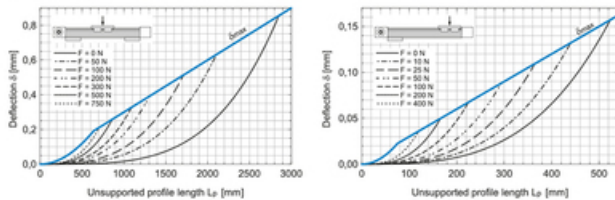

① The linear units do not include any safety stroke.
Absolute stroke = Effective stroke + 2 x safety stroke.

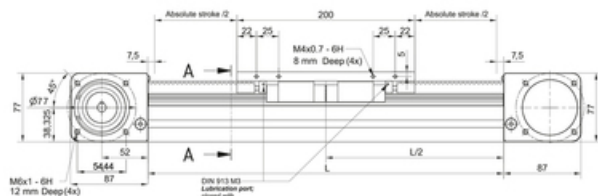

① Journal with or without keyway ① All dimensions in mm. Drawings scales are not equal.

① The linear units do not include any safety stroke.
Absolute stroke = Effective stroke + 2 x safety stroke.

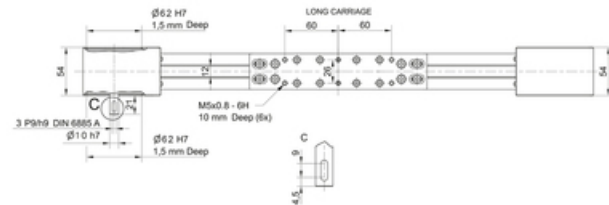

① Journal with or without keyway ① All dimensions in mm. Drawings scales are not equal.

① The linear units do not include any safety stroke.
Absolute stroke = Effective stroke + 2 x safety stroke.

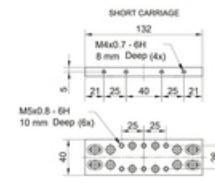

① Journal with or without keyway ① All dimensions in mm. Drawings scales are not equal.

Linear Unit MTJ ECO 40

TYPE 0

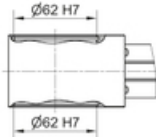
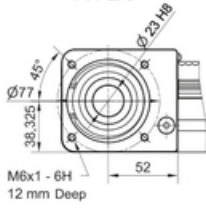

TYPE 1 L and 1 R

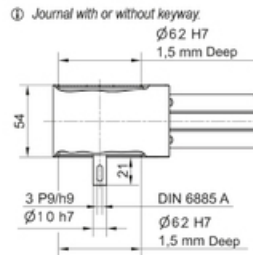
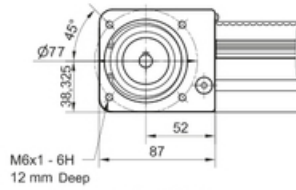

TYPE 2

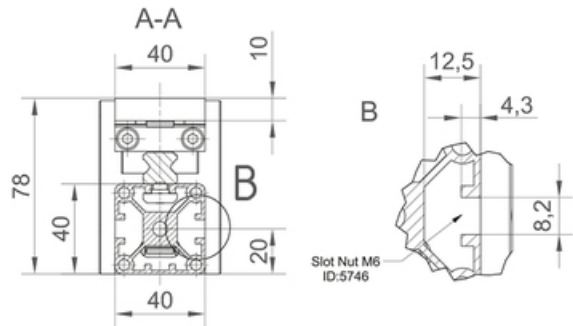
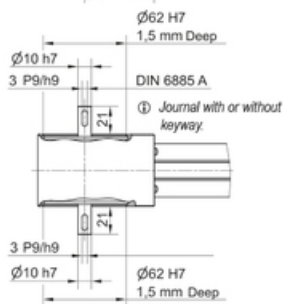
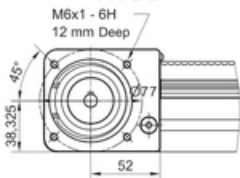

Ⓜ All dimensions in mm. Drawings scales are not equal.

	MTJ 40 ECO	MTJ 40 ECO	MTJ 40 ECO
MOTOR			
	Available on request	Available on request	Available on request
GEAR REDUCER + MOTOR			
GEAR REDUC. 90° + MOTOR			

Defining of the linear unit length

$L = \text{Effective stroke} + 2 \times \text{Safety stroke} + L_v + 15 \text{ mm}$

$L_{\text{total}} = L + 174 \text{ mm}$

Left side (L)

$L_v - \text{Long carriage} = 200 \text{ mm}$

$L_v - \text{Short carriage} = 132 \text{ mm}$

Right side (R)

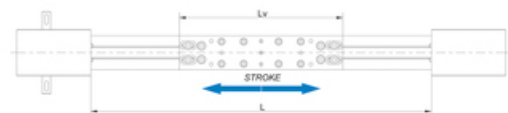

Linear Unit MTJ ECO 40

Double Carriage

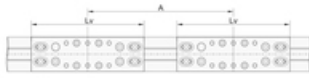

$$L = \text{Effective stroke} + 2 \times \text{Safety stroke} + Lv + A + 15 \text{ mm}$$
$$L_{\text{total}} = L + 174 \text{ mm}$$

} A \geq Lv

General data

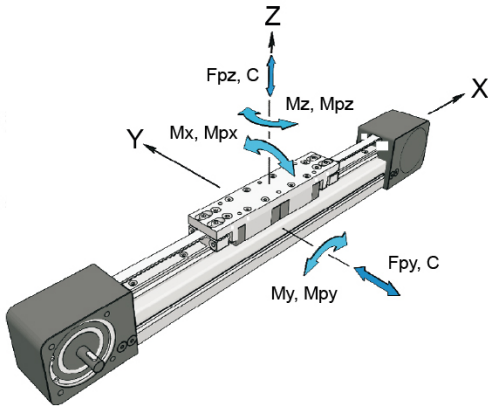

For length/stroke over the stated value, please contact Rollco.
 Values for max. stroke are not valid for double carriage (equation of defining the linear unit length for particular size of the linear unit needs to be used).
 For minimum stroke below the stated value, please contact Rollco.

Recommended values of loads

All the data of static and dynamic moments and load capacities stated in the upper table are theoretical without considering any safety factor. The safety factor depends on the application and its requested safety. We recommend a minimum safety factor ($f_s = 5.0$).

Designation	Carriage Length L_v (mm)	Dynamic Moment M_x (Nm)	Dynamic Moment M_y (Nm)	Dynamic Moment M_z (Nm)	Dynamic Load Capacity C (N)
MTJ 40 ECO S	132	79	59	59	9900
MTJ 40 ECO L	200	158	660	660	19800

Designation	Static Load Capacity C_0 (N)	Max. Permissible Loads Forces F_{py} (N)	Max. Permissible Loads Forces F_{pz} (N)	Max. Permissible Loads Moments M_{px} (Nm)	Max. Permissible Loads Moments M_{py} (Nm)	Max. Permissible Loads Moments M_{pz} (Nm)
MTJ 40 ECO S	17500	3270	5100	34	34	34
MTJ 40 ECO L	35000	6540	10190	60	341	219

Designation	Moved Mass (kg)	Max. Repeatability (mm)	Max. Length L_{max} (mm)	Max. Stroke (mm)	Min. Stroke (mm)
MTJ 40 ECO S	0.45	± 0.1	5960	5813	40
MTJ 40 ECO L	0.72	± 0.1	5960	5745	40

General data double carriage

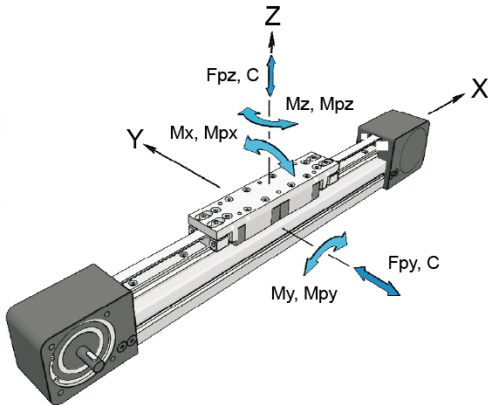

A - Distance between carriages.

Designation	Carriage version	Dynamic Load Capacity C (N)	Static Load Capacity C0 (N)	Dynamic Moment Mx (Nm)	Dynamic Moment My (Nm)
MTJ 40 ECO S	S2	19800	35000	158	9.9 × A (mm)
MTJ 40 ECO L	L2	39600	70000	317	19.8 × A (mm)

Designation	Dynamic Moment Mz (Nm)	Max. Permissible Loads Forces Fpy (N)	Max. Permissible Loads Forces Fpz (N)	Max. Permissible Loads Moments Mpx (Nm)	Max. Permissible Loads Moments Mpy (Nm)	Max. Permissible Loads Moments Mpz (Nm)
MTJ 40 ECO S	9.9 × A (mm)	6540	10190	68	5.1 × A (mm)	3.3 × A (mm)
MTJ 40 ECO L	19.8 × A (mm)	13080	20380	120	10.1 × A (mm)	6.5 × A (mm)

Drive data

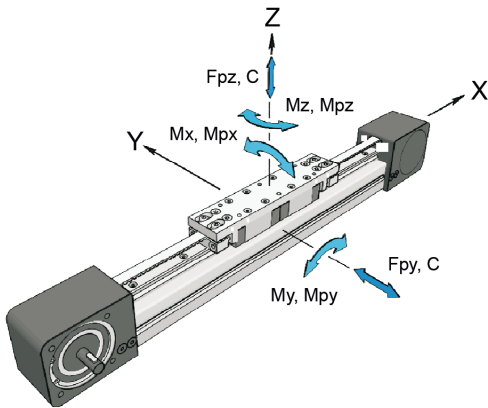

The stated values are for strokes up to 500 mm.
No load torque value increases with stroke elongation.

Max. acceleration (m/s²): 70

For acceleration over the stated value, please contact Rollco.

Mass calculation does not include mass of motor, reduction gear, switches and clamps.

Abs. stroke	Absolute stroke [mm]
A	Distance between carriages [mm]
nc	Number of carriages

Designation	Max. Travel Speed (m/s)	No Load Torque (Nm)	Pulley Drive Ratio (mm/rev)	Pulley Diameter	Belt Type
MTJ 40 ECO S	3	1.0 × nc	180	57.31	AT5
MTJ 40 ECO L	3	1.1 × nc	180	57.31	AT5

Designation	Belt Width	Max. Force Transmitted by Belt (N)	Specific Spring Constant Cspec (N)	Max. Drive Torque (Nm)	Planar Moment of Inertia Iy (cm ⁴)	Planar Moment of Inertia Iz (cm ⁴)
MTJ 40 ECO S	12	262	235000	7.5	9.53	9.21
MTJ 40 ECO L	12	262	235000	7.5	9.53	9.21

Mass and Mass moment

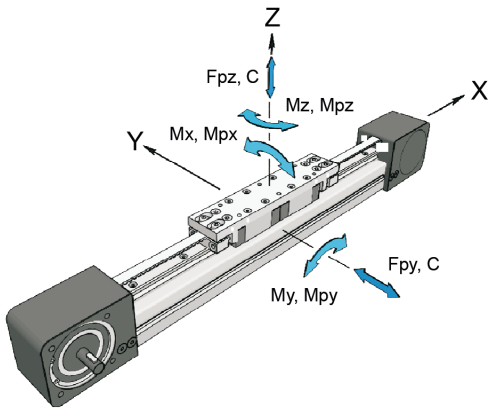

The stated values are for strokes up to 500 mm.
No load torque value increases with stroke elongation.

Max. acceleration (m/s²): 70

For acceleration over the stated value, please contact Rollco.

Mass calculation does not include mass of motor, reduction gear, switches and clamps.

Abs. stroke	Absolute stroke [mm]
A	Distance between carriages [mm]
nc	Number of carriages

Designation	Mass of Linear Unit (kg)	Mass Moment of Inertia (10 ⁻⁵ kg m ²)	Planar Moment of Inertia Iy (cm ⁴)	Planar Moment of Inertia Iz (cm ⁴)	Moved Mass (kg)
MTJ 40 ECO S	$3.1 + 0.003 \times (\text{Abs. Stroke} + (nc - 1) \times A) + 0.45 \times (nc - 1)$	$70.1 + 0.007 \times (\text{Abs. Stroke} + (nc - 1) \times A) + 36.9 \times (nc - 1)$	9.53	9.21	0.45
MTJ 40 ECO L	$3.55 + 0.003 \times (\text{Abs. Stroke} + (nc - 1) \times A) + 0.72 \times (nc - 1)$	$92.3 + 0.007 \times (\text{Abs. Stroke} + (nc - 1) \times A) + 59.1 \times (nc - 1)$	9.53	9.21	0.72

Designation	No Load Torque (Nm)
MTJ 40 ECO S	1.0 × nc
MTJ 40 ECO L	1.1 × nc