

# **TECHNICAL INFORMATION**

## **MINI LINEAR UNITS**

### **MGBS & MGTB**

---



# Index

<b>GENERAL INFORMATION.....</b>	<b>4</b>
Product overview.....	4
Accessory overview.....	6
<b>TECHNICAL INFORMATION.....</b>	<b>9</b>
MGBS .....	9
Operating conditions.....	9
Deflection of the linear unit as a function of a vertical force and the unsupported profile length.....	9
Maximum travel speed of the carriage as a function of the absolute stroke .....	11
Maximum axial load as a function of absolute stroke.....	12
Maximum axial load as a function of the travel speed of the carriage.....	13
Maximum horizontal payload as a function of the travel speed and acceleration of the carriage.....	14
Maximum vertical payload as a function of the travel speed and acceleration of the carriage.....	16
Maximum axial load as a function of travel speed and acceleration of the carriage ..	18
Maximum horizontal payload as a function of position change and positioning time of the carriage.....	20
Maximum vertical payload as a function of position change and positioning time of the carriage.....	22
MGTB .....	24
Operating conditions.....	24
Deflection of the linear unit as a function of a vertical force and the unsupported profile length.....	24
Deformation of the toothed belt under an axial load.....	26
Maximum horizontal payload as a function of the travel speed and acceleration of the carriage.....	27
Maximum vertical payload as a function of the travel speed and acceleration of the carriage.....	28
Maximum horizontal payload as a function of position change and positioning time of the carriage.....	30
Maximum vertical payload as a function of position change and positioning time of the carriage.....	31
<b>SERVICE LIFE .....</b>	<b>32</b>
Linear guiding.....	32
Permissible load .....	33
Service life .....	33
Ball screw drive.....	34
Permissible load .....	34
Service life .....	35
Mini linear unit MGBS.....	36
Mini linear unit MGTB.....	36
<b>CALCULATIONS .....</b>	<b>37</b>
Load torque.....	37

<b>ORDER CODES.....</b>	<b>38</b>
MGBS .....	38
MGTB .....	40
Motor Adapter VK.....	42
Couplings .....	43
Motor side drive MSD with a timing belt.....	44
Motor.....	45
Drive .....	46
Drive-motor cables .....	47
Power and signal cables.....	48

Information in this document is subject to change. Owing to continued product development, Rollco reserves the right to make alterations without prior notice. Every care has been taken to ensure the accuracy of the information, but no liability can be accepted for any errors or omissions.

All information and content included in this document, such as text, and images, are property of Rollco. Any reproduction, even partial, is allowed only by written permission by Rollco.

---

## Product overview

MGBS & MGTB are modular and cost-effective rod-less electromechanical linear drive units. They feature a high capacity and high precision linear guide system with either a precision ball screw (MGBS) or a timing belt transmission (MGTB) to convert a rotary input to linear motion and force.

### Endurance

Our range of miniature units is designed to survive in the most intense automation situations, counting several million cycles over its lifetime. And this with practically no need for maintenance. High-quality components are used from inside and out, starting with a robust anodized aluminium extrusion as the base. Inside only first-rate bearings and ball screws are used.

### Sustainability

Our miniature linear units have highly efficient mechanical solutions, and the size and form factor to easily replace a lot of functions traditionally driven by pneumatics. The faster and more frequent the motion is, the greater the potential energy saving. On a system level, pneumatic motion has a typical efficiency between 5 to 10 %. Electromechanical systems with low friction mechanics easily achieve over 50 % system efficiency.

### Modularity

The MG series is a further extension of the MCE and MSCE miniature cylinder series, sharing the same outer shape and mounting hardware. The motor interfaces, in-line with a coupling or parallel over a belt drive, are the same for both MG and MCE/MSCE. To enable the best value and shortest delivery time, MG is batch produced and stocked in several standard stroke lengths.

## Proven system performance with our stepper motor system

All our miniature drive units can be calculated and mechanically adapted for your preferred motor, given it is within suitable physical dimensions. But to save time and cost, our stepper motor system is an excellent choice. The performance of all combinations of linear miniature units and our motors is already calculated and validated.

### Characteristics

- Up to 1500 mm/s linear speed
- < 0.05 mm mechanical backlash
- < 0.03 mm uni-directional repeatability (MGBS, ball screw)
- < 0.16 mm uni-directional repeatability (MGTB, timing belt)
- 90 % typical mechanical efficiency
- Linear guided with ball-raced guiding
- In-line or parallel-mounted motor options
- Maintenance free
- Prepared for multi-axis arrangements.

## Motor adapter VK with a coupling and a motor

MGBS



MGTB

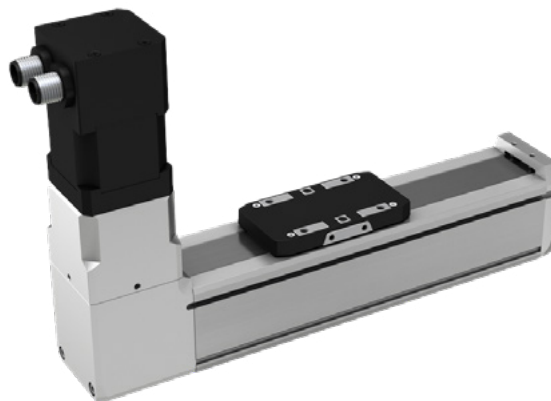

## Motor side drive with timing a belt and a motor

MGBS

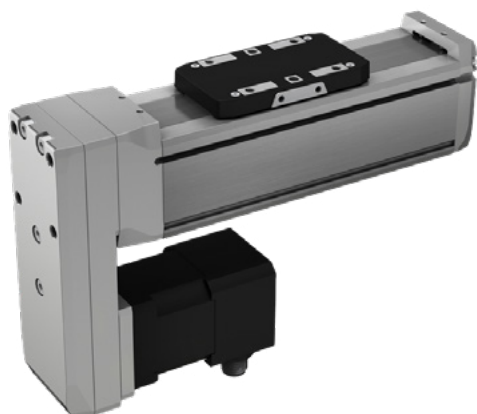

## Without a preassembled motor

MGBS



MGTB



# Accessory overview

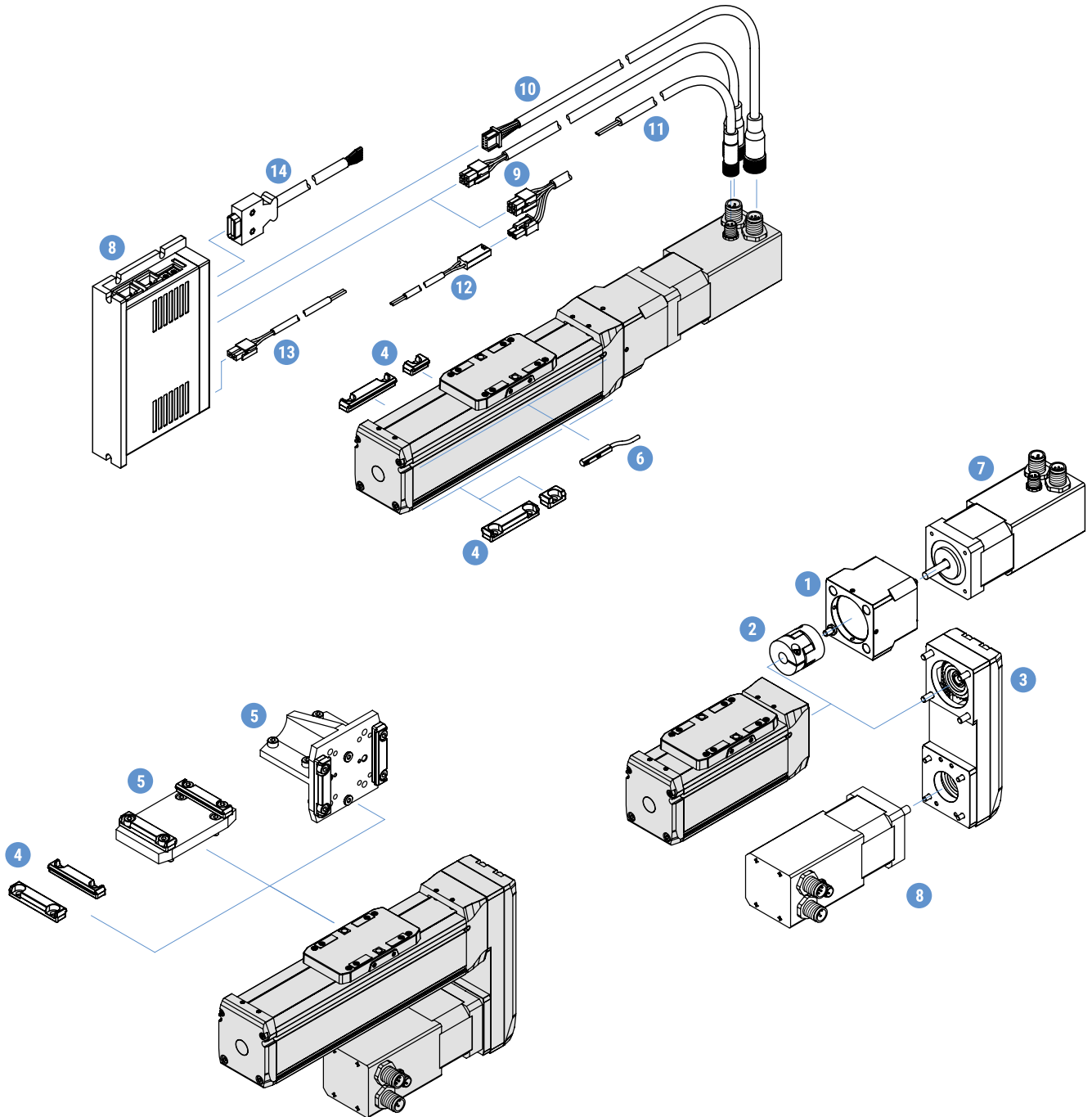

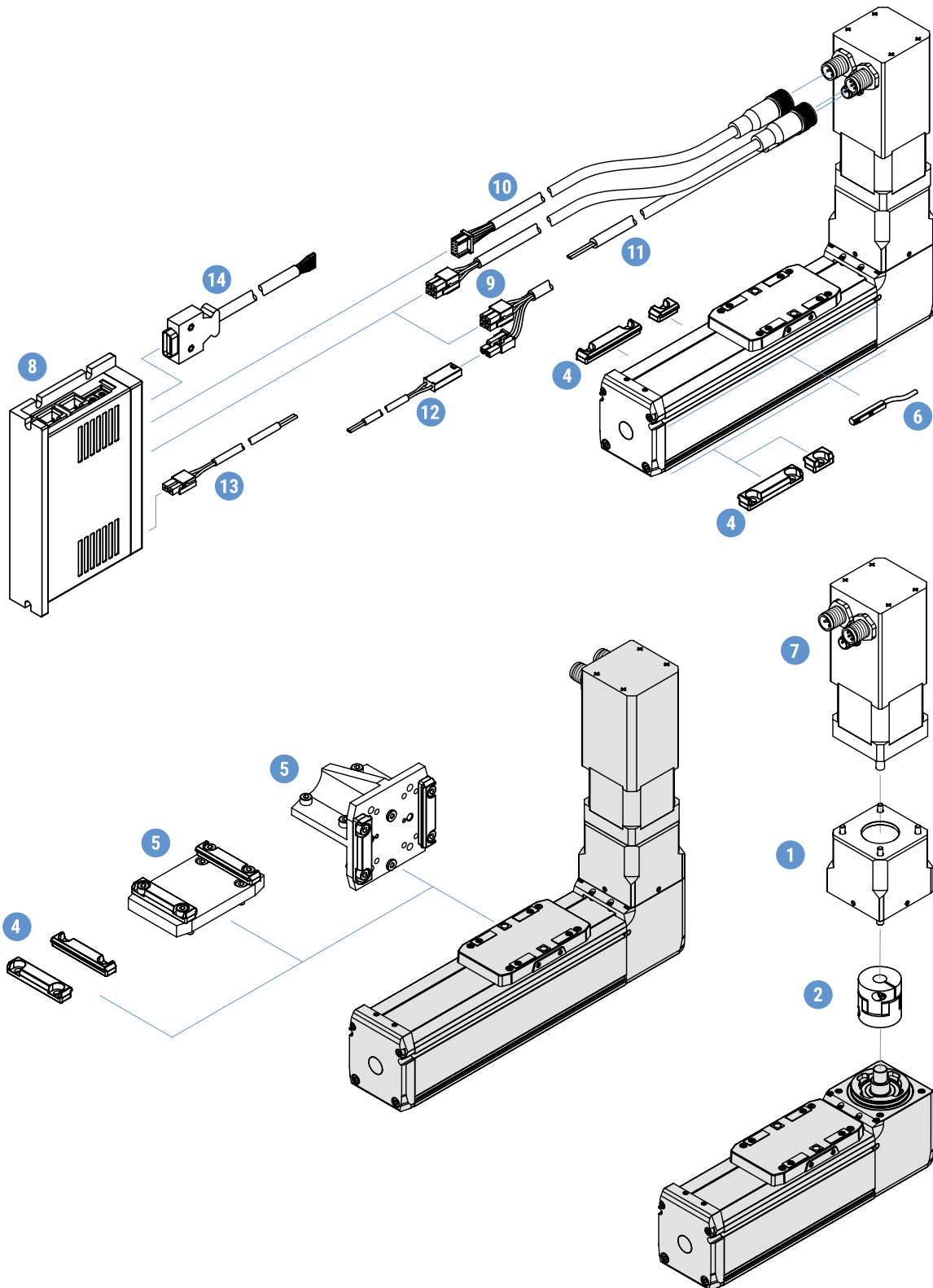

#	Accessories	Compatible with						Type
		MGBS 32	MGBS 45	MGBS 60	MGTB 32	MGTB 45	MGTB 60	
1	Motor adapter VK	•	•	•	•	•	•	Motor adapters
2	Coupling	•	•	•	•	•	•	Elastomer couplings
3	Motor side drive MSD	•	•	•				Motor side drives
4	Clamping fixture	•	•	•	•	•	•	Mounting attachment
5	Connection plate	•	•	•	•	•	•	
6	Magnetic field sensor	•	•	•	•	•	•	Limit switches
7	Motor	•	•	•	•	•	•	Motors
8	Drive	•	•	•	•	•	•	Drives
9	Motor cable	•	•	•	•	•	•	Cables
10	Encoder cable	•	•	•	•	•	•	
11	Brake cable	•	•	•	•	•	•	
12	Brake to terminal cable	•			•			
13	Power cable	•	•	•	•	•	•	
14	Signal cable	•	•	•	•	•	•	

For the stepper motor size of 28, the motor and brake cables are combined into one cable. For connectivity between the brake and terminal, an additional brake to terminal cable is used



# MGBS

## Operating conditions

Ambient temperature	0 °C - +50 °C
Ambient temperature without a motor	0 °C - +60 °C
Protection class	IP40
Duty cycle	100 %
Maintenance	Life-time pre-lubricated

## Deflection of the linear unit as a function of a vertical force and the unsupported profile length

In the following diagrams, the deflection of the linear unit as a function of a vertical force and unsupported profile length is presented. For the case of both ends of the profile are supported and for the case of a console mounting the left and the right diagrams below should be considered, respectively.

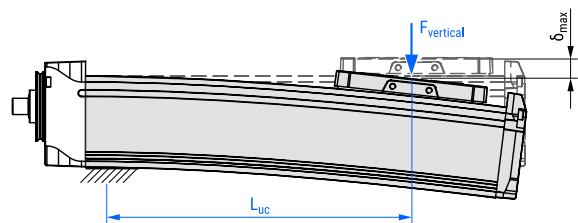
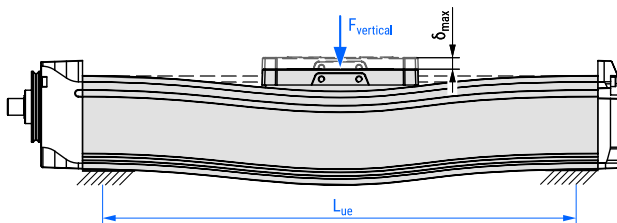

**MGBS 32**

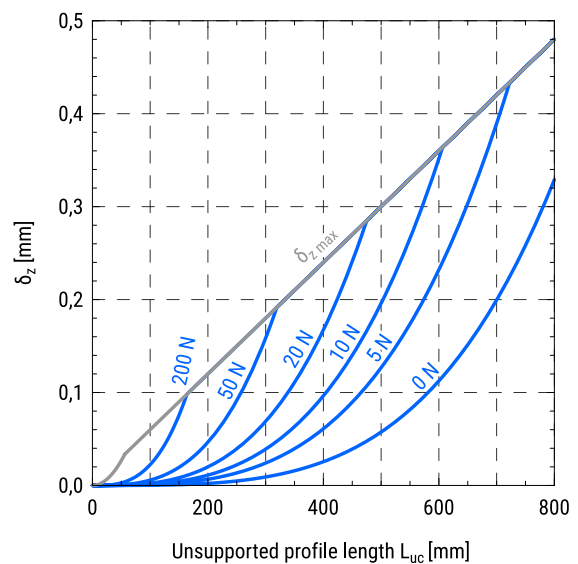
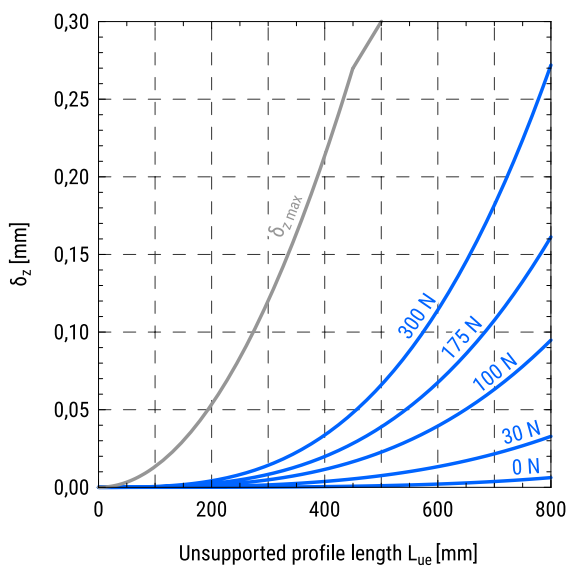

**MGBS 45**

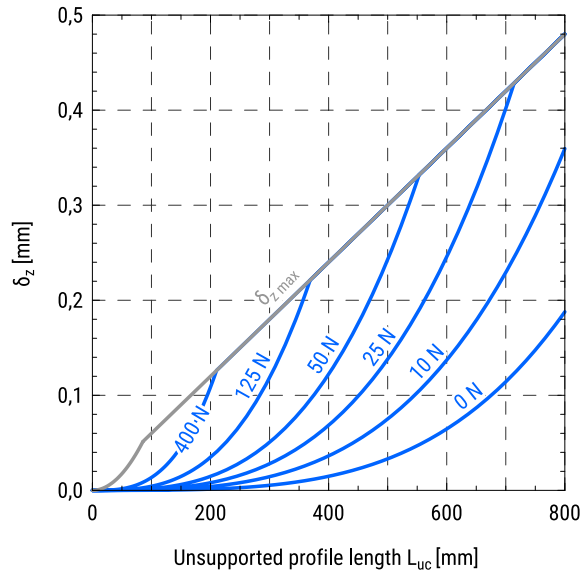
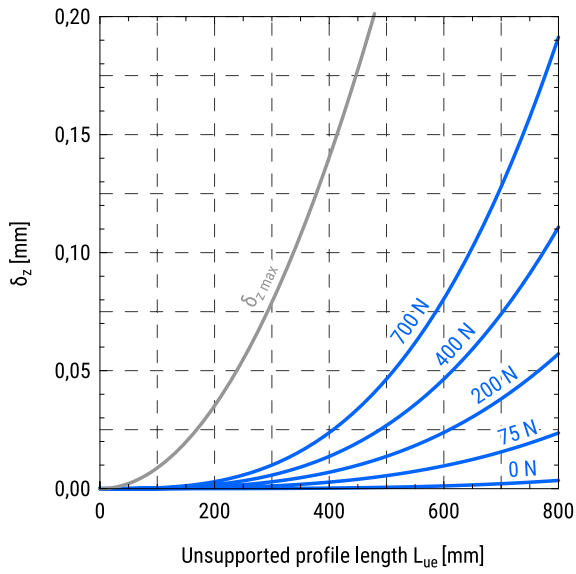

**MGBS 60**

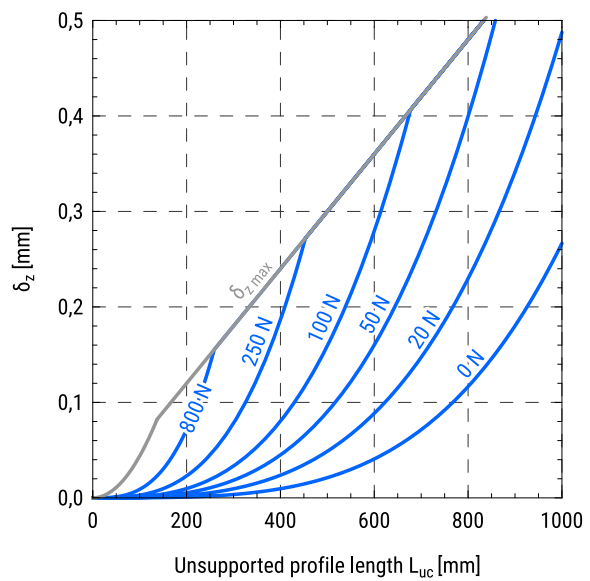
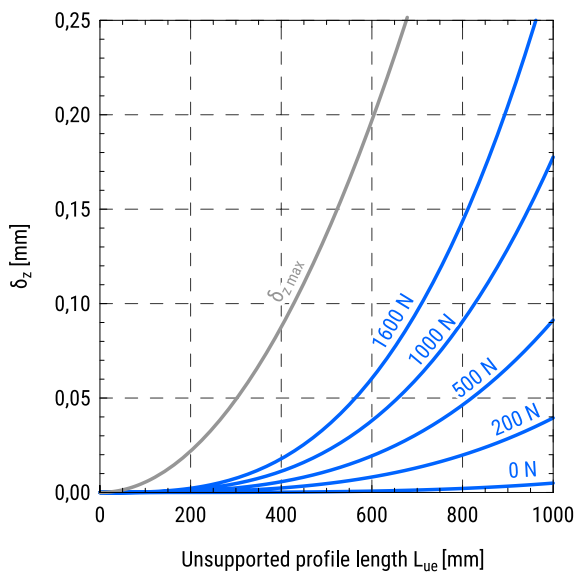

## Maximum travel speed of the carriage as a function of the absolute stroke

In the following diagrams, the maximum travel speed of the carriage as a function of absolute stroke for a different ball screw lead is presented.

Values on the curves represent a ball screw lead of the linear unit.

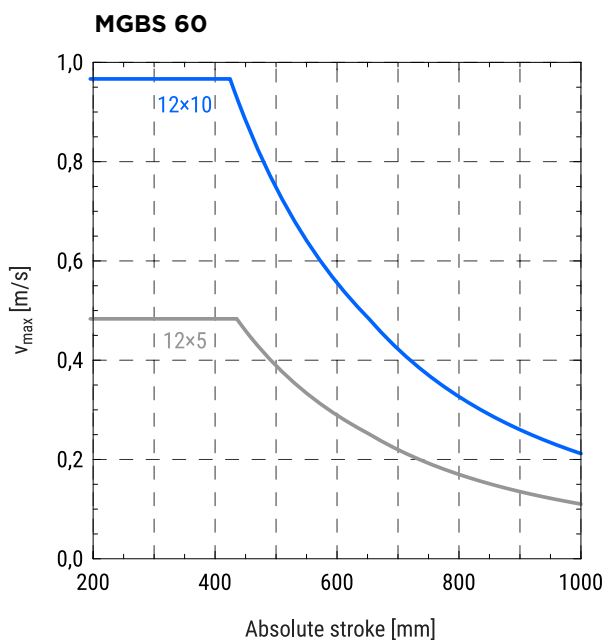
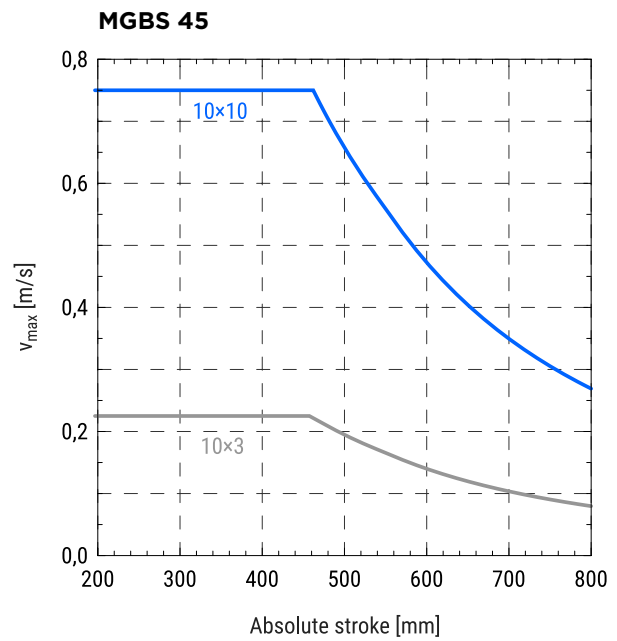
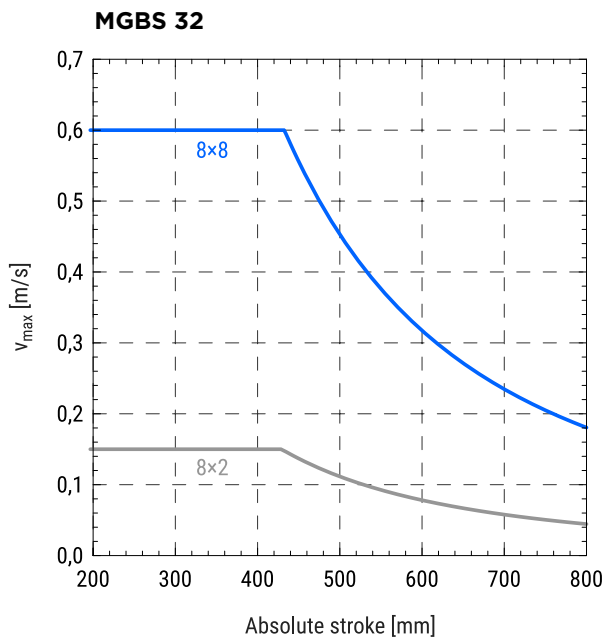

## Maximum axial load as a function of absolute stroke

In the following diagrams, the maximum axial load applied to the carriage of the linear unit as a function of absolute stroke is presented.

**MGBS 32**

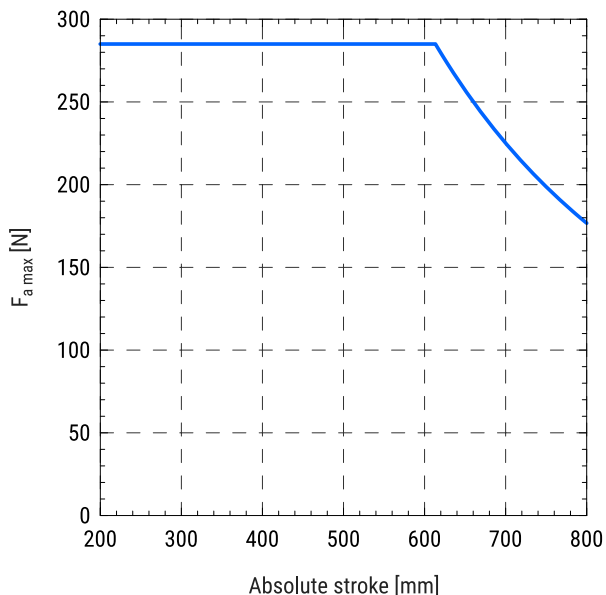

**MGBS 45**

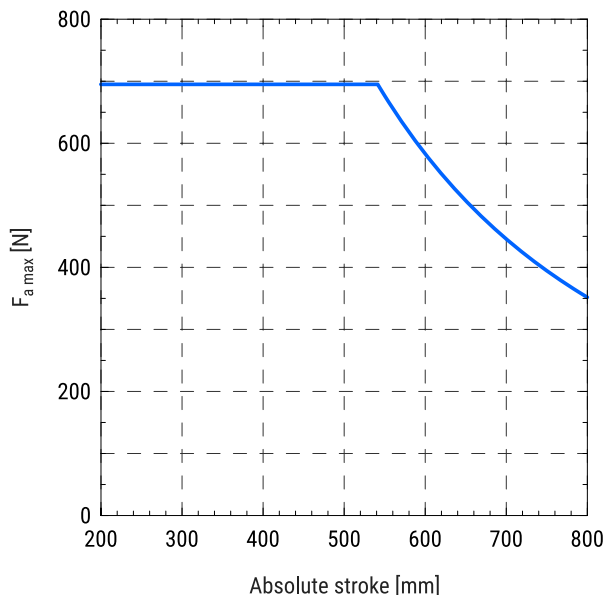

**MGBS 60**

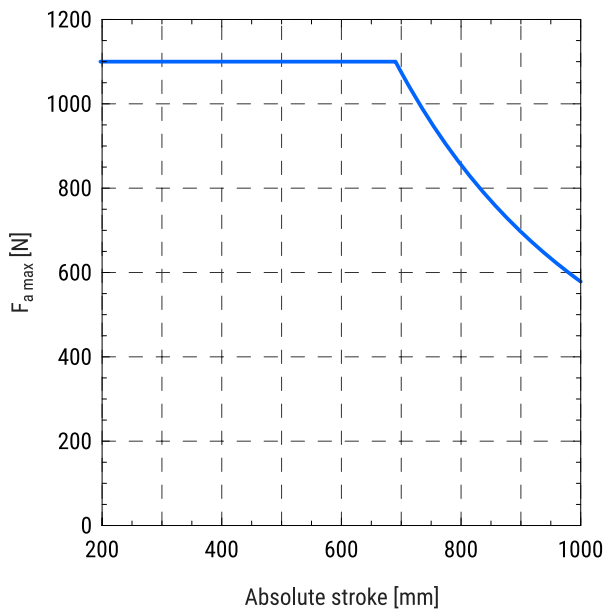

## Maximum axial load as a function of the travel speed of the carriage

In the following diagrams, the maximum axial loads applied to the carriage as a function of travel speed for a different values of the absolute stroke are presented.

Values on the curves represent an absolute stroke of the linear unit.

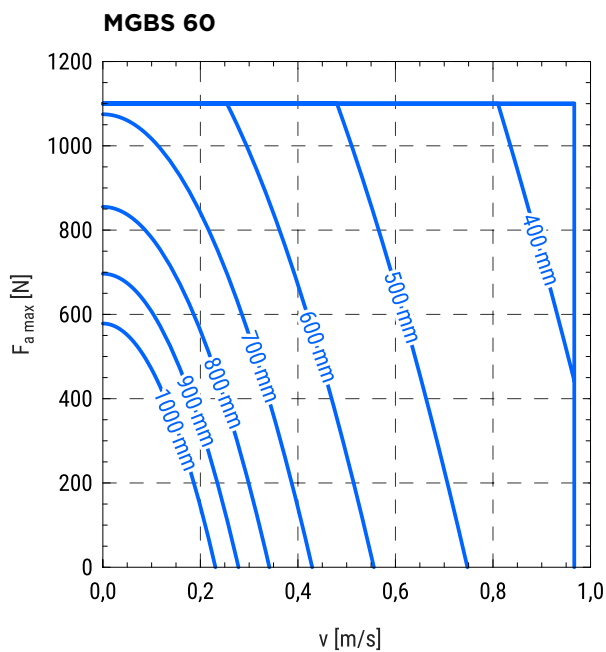
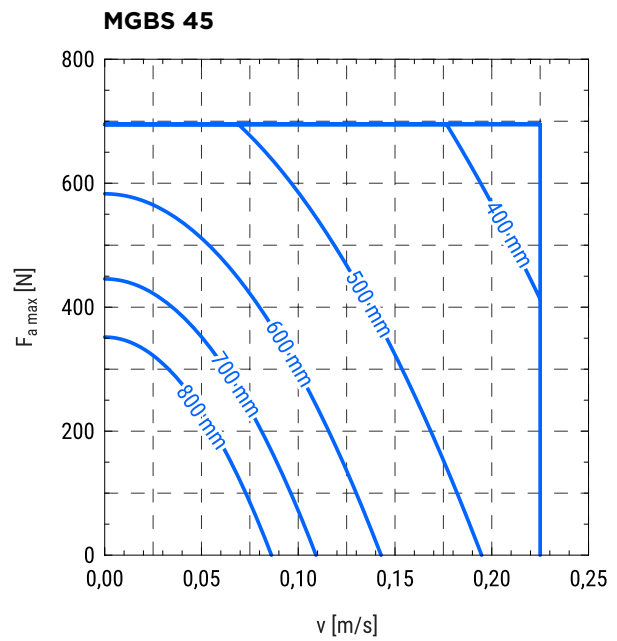
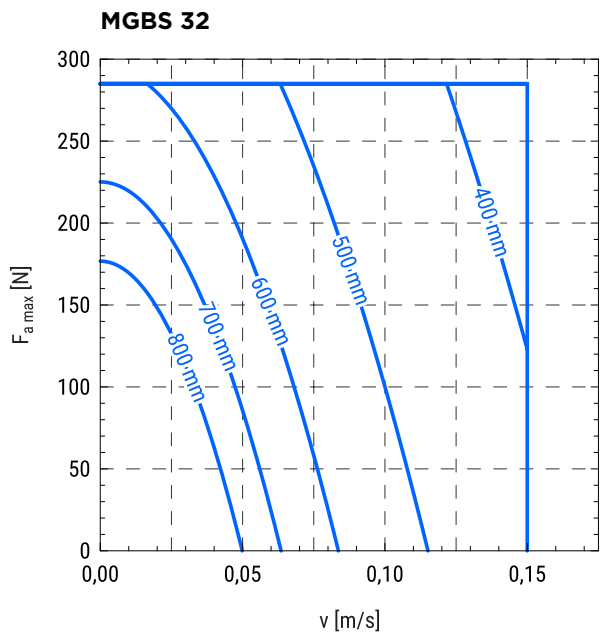
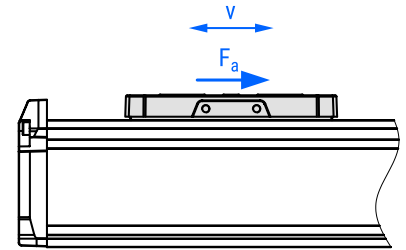

## Maximum horizontal payload as a function of the travel speed and acceleration of the carriage

In the following diagrams, maximum horizontal payloads applied to the carriage as a function of the travel speed for different accelerations, different ball screw leads and different combinations of the standard motors are presented. Motor adapter VK and a motor side drive MSD are also considered.

The diagrams shown below are valid for the linear units with an absolute stroke of 500 mm. Limitations regarding travel speed and axial loads in respect of absolute stroke are not considered and should be taken into account separately.

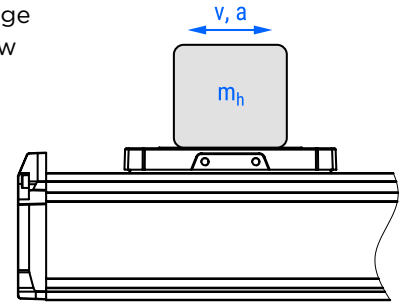

### MGBS 32

8 × 2 with a stepper motor □28

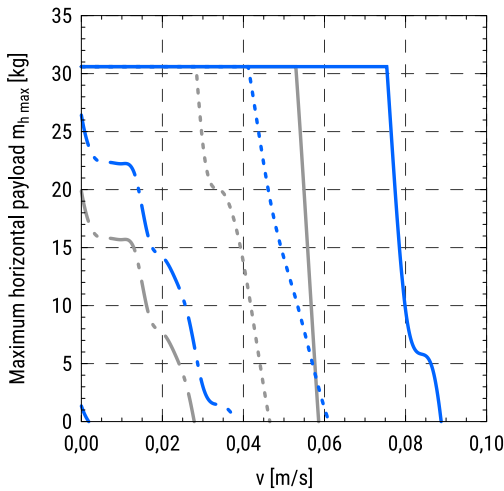

8 × 8 with a stepper motor □28

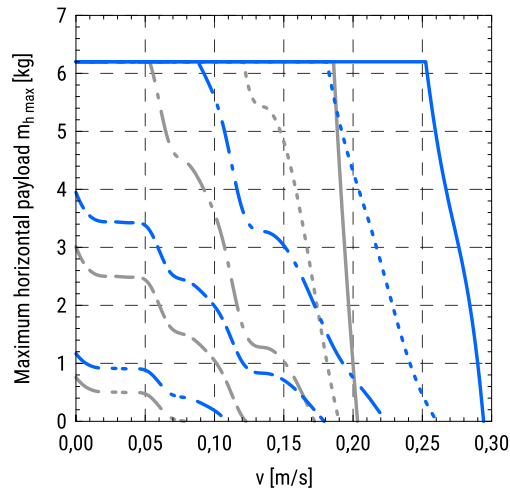

- MGBS in combination:
- with VK
  - with MSD
- Acceleration/Deceleration:
- $a = 0,5 \text{ m/s}^2$
  - - -  $a = 2 \text{ m/s}^2$
  - · -  $a = 5 \text{ m/s}^2$
  - - -  $a = 10 \text{ m/s}^2$
  - · -  $a = 20 \text{ m/s}^2$

### MGBS 32

8 × 2 with a stepper motor □42

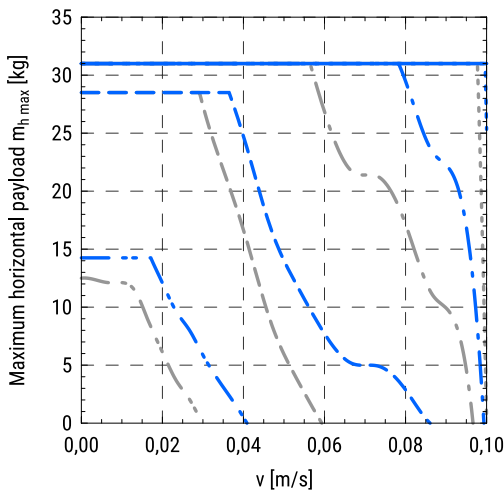

8 × 8 with a stepper motor □42

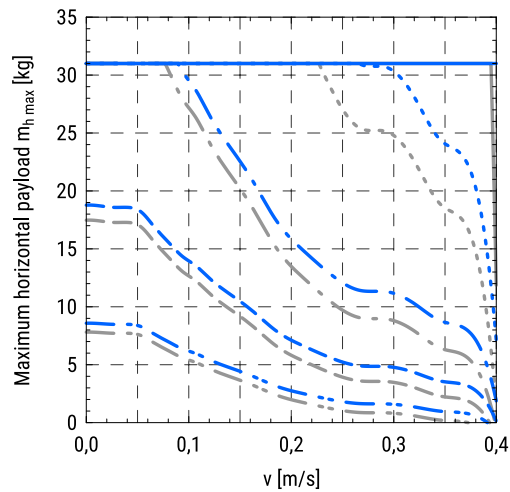

- MGBS in combination:
- with VK
  - with MSD
- Acceleration/Deceleration:
- $a = 0,5 \text{ m/s}^2$
  - - -  $a = 2 \text{ m/s}^2$
  - · -  $a = 5 \text{ m/s}^2$
  - - -  $a = 10 \text{ m/s}^2$
  - · -  $a = 20 \text{ m/s}^2$

**MGBS 45**

10 × 3 with a stepper motor □42

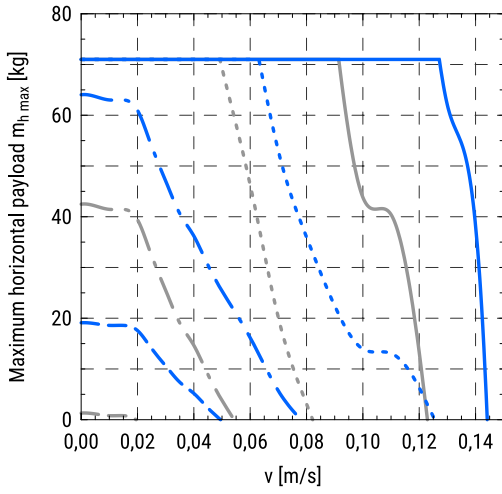

10 × 10 with a stepper motor □42

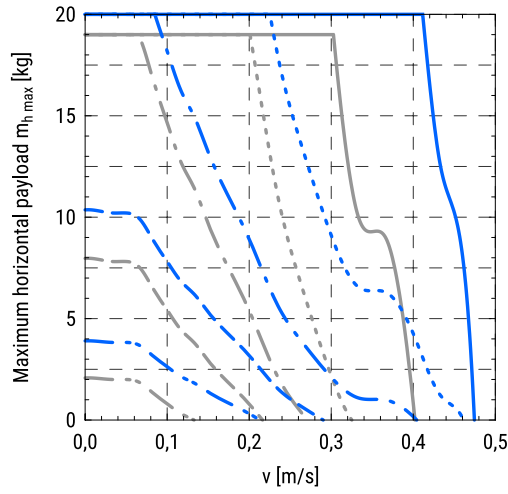

MGBS in combination:  
 — with VK  
 — with MSD

Acceleration/Deceleration:  
 — a = 0,5 m/s<sup>2</sup>  
 ··· a = 2 m/s<sup>2</sup>  
 - - - a = 5 m/s<sup>2</sup>  
 - · - a = 10 m/s<sup>2</sup>  
 - - - a = 20 m/s<sup>2</sup>

**MGBS 45**

10 × 3 with a stepper motor □56

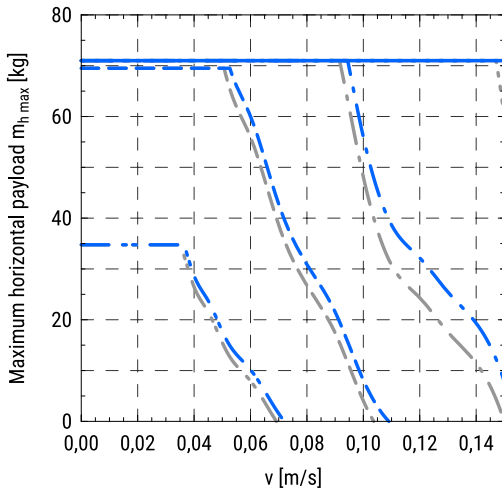

10 × 10 with a stepper motor □56

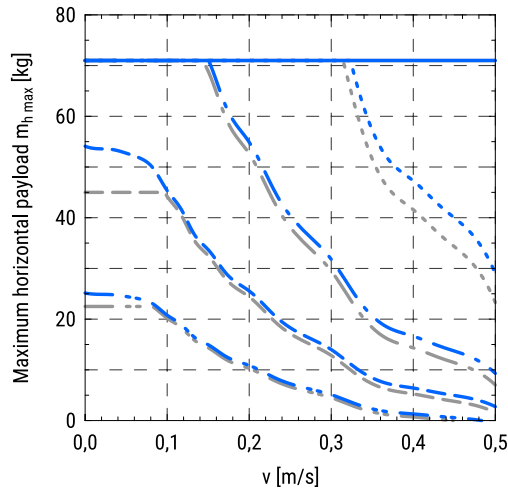

MGBS in combination:  
 — with VK  
 — with MSD

Acceleration/Deceleration:  
 — a = 0,5 m/s<sup>2</sup>  
 ··· a = 2 m/s<sup>2</sup>  
 - - - a = 5 m/s<sup>2</sup>  
 - · - a = 10 m/s<sup>2</sup>  
 - - - a = 20 m/s<sup>2</sup>

**MGBS 60**

12 × 5 with a stepper motor □56

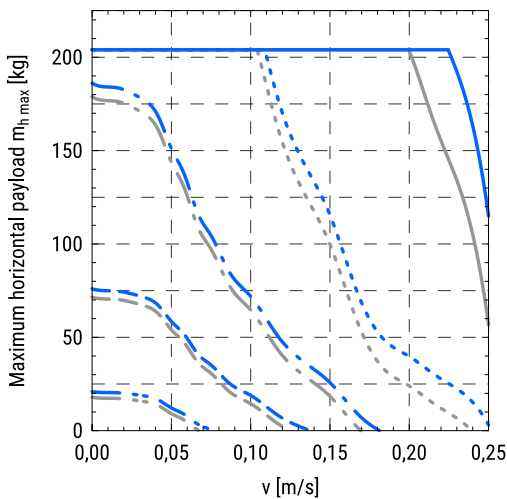

12 × 10 with a stepper motor □56

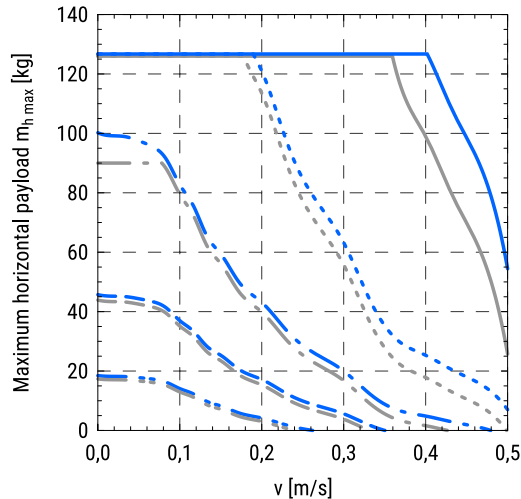

MGBS in combination:  
 — with VK  
 — with MSD

Acceleration/Deceleration:  
 — a = 0,5 m/s<sup>2</sup>  
 ··· a = 2 m/s<sup>2</sup>  
 - - - a = 5 m/s<sup>2</sup>  
 - · - a = 10 m/s<sup>2</sup>  
 - - - a = 20 m/s<sup>2</sup>

## Maximum vertical payload as a function of the travel speed and acceleration of the carriage

In the following diagrams, maximum vertical payloads applied to the carriage as a function of the travel speed for different accelerations, different ball screw leads and different combinations of the standard motors are presented. Motor adapter VK and a motor side drive MSD are also considered.

The diagrams shown below are valid for the linear units with an absolute stroke of 500 mm. Limitations regarding travel speed and axial loads in respect of absolute stroke are not considered and should be taken into account separately.

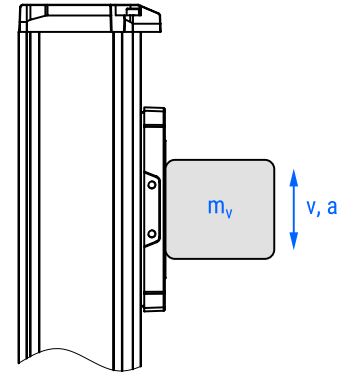

### MGBS 32

8 × 2 with a stepper motor □28

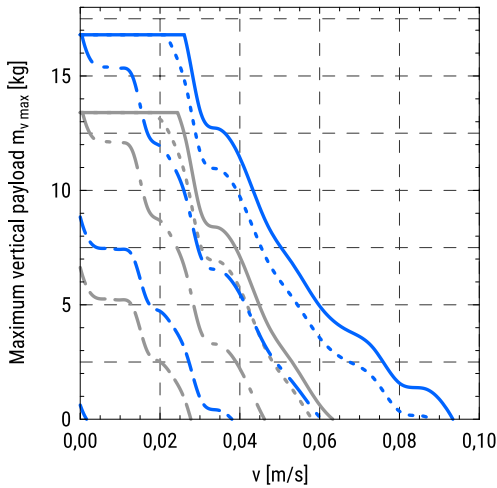

8 × 8 with a stepper motor □28

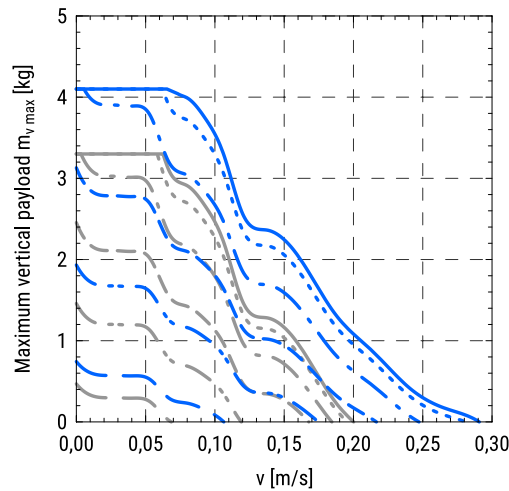

MGBS in combination:

— with VK  
— with MSD

Acceleration/Deceleration:

—  $a = 0 \text{ m/s}^2$   
- - -  $a = 0,5 \text{ m/s}^2$   
- · -  $a = 2 \text{ m/s}^2$   
- - -  $a = 5 \text{ m/s}^2$   
- · -  $a = 10 \text{ m/s}^2$   
- - -  $a = 20 \text{ m/s}^2$

### MGBS 32

8 × 2 with a stepper motor □42

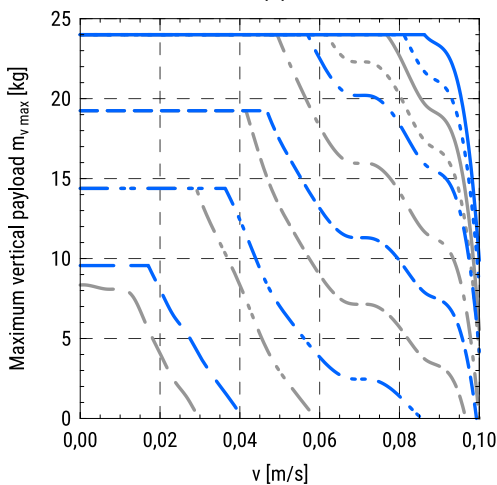

8 × 8 with a stepper motor □42

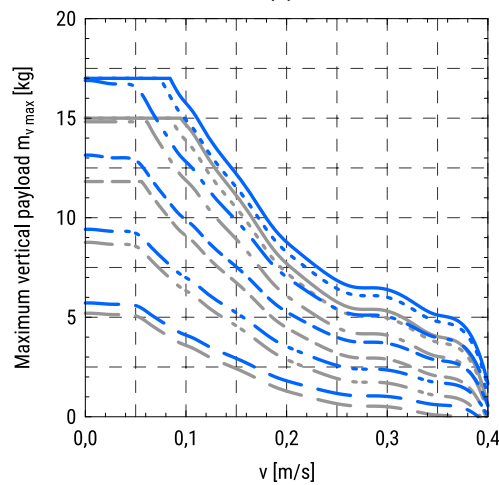

MGBS in combination:

— with VK  
— with MSD

Acceleration/Deceleration:

—  $a = 0 \text{ m/s}^2$   
- - -  $a = 0,5 \text{ m/s}^2$   
- · -  $a = 2 \text{ m/s}^2$   
- - -  $a = 5 \text{ m/s}^2$   
- · -  $a = 10 \text{ m/s}^2$   
- - -  $a = 20 \text{ m/s}^2$



**MGBS 45**

10 × 3 with a stepper motor □42

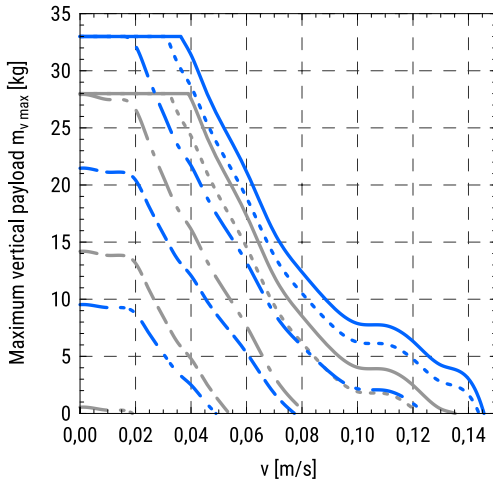

10 × 10 with a stepper motor □42

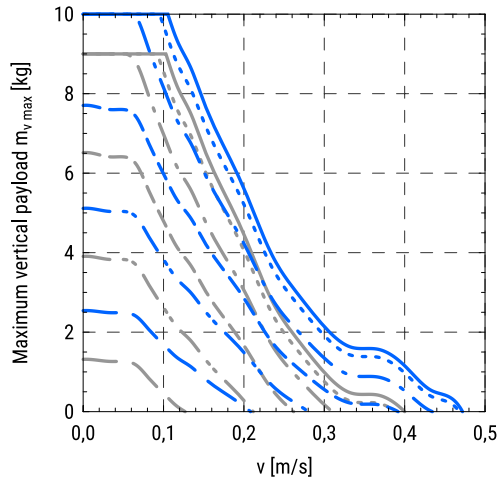

- MGBS in combination:
- with VK
  - with MSD
- Acceleration/Deceleration:
- a = 0 m/s<sup>2</sup>
  - - - a = 0,5 m/s<sup>2</sup>
  - · - a = 2 m/s<sup>2</sup>
  - - - a = 5 m/s<sup>2</sup>
  - · - a = 10 m/s<sup>2</sup>
  - - - a = 20 m/s<sup>2</sup>

**MGBS 45**

10 × 3 with a stepper motor □56

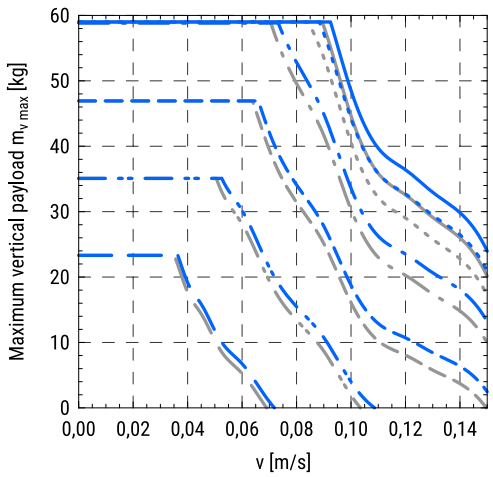

10 × 10 with a stepper motor □56

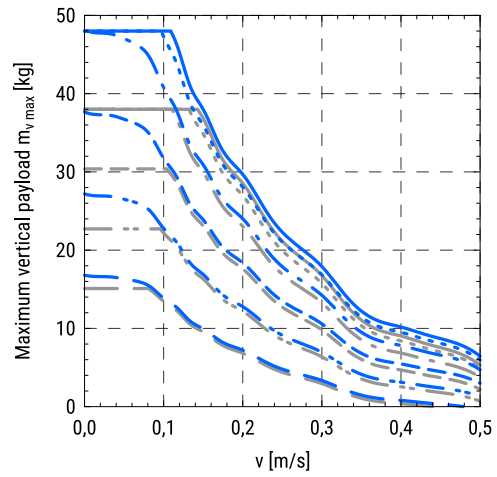

- MGBS in combination:
- with VK
  - with MSD
- Acceleration/Deceleration:
- a = 0 m/s<sup>2</sup>
  - - - a = 0,5 m/s<sup>2</sup>
  - · - a = 2 m/s<sup>2</sup>
  - - - a = 5 m/s<sup>2</sup>
  - · - a = 10 m/s<sup>2</sup>
  - - - a = 20 m/s<sup>2</sup>

**MGBS 60**

12 × 5 with a stepper motor □56

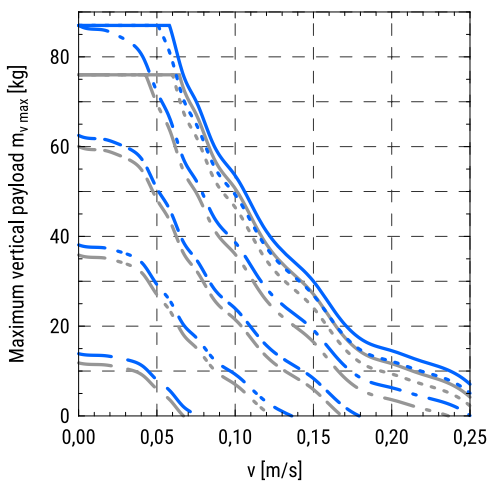

12 × 10 with a stepper motor □56

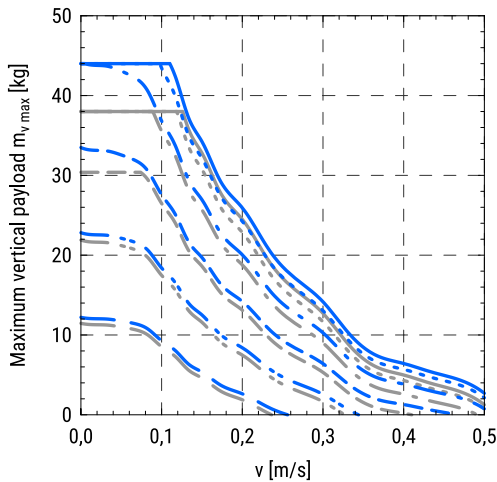

- MGBS in combination:
- with VK
  - with MSD
- Acceleration/Deceleration:
- a = 0 m/s<sup>2</sup>
  - - - a = 0,5 m/s<sup>2</sup>
  - · - a = 2 m/s<sup>2</sup>
  - - - a = 5 m/s<sup>2</sup>
  - · - a = 10 m/s<sup>2</sup>
  - - - a = 20 m/s<sup>2</sup>

# Maximum axial load as a function of travel speed and acceleration of the carriage

In the following diagrams, maximum axial load applied to the carriage as a function of the travel speed for different accelerations, different ball screw leads and different combinations of the standard motors is presented. Motor adapter VK and a motor side drive MSD are also considered.

The diagrams shown below are valid for the linear units with an absolute stroke of 500 mm. Limitations regarding travel speed and axial loads in respect of absolute stroke are not considered and should be taken into account separately.

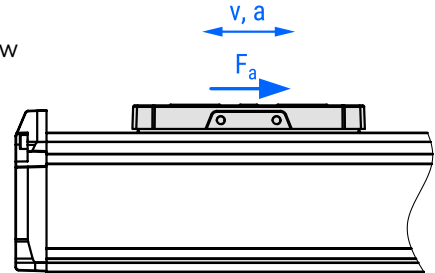

## MGBS 32

8 × 2 with a stepper motor □28

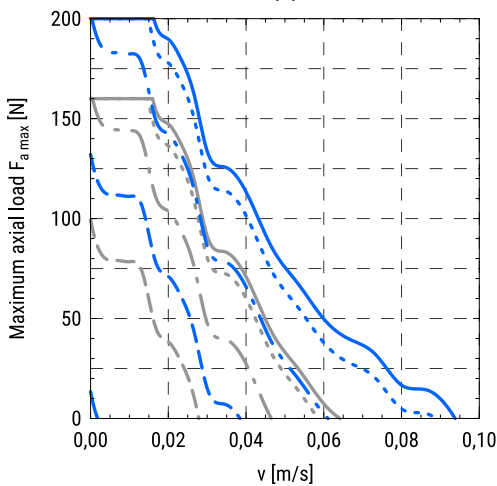

8 × 8 with a stepper motor □28

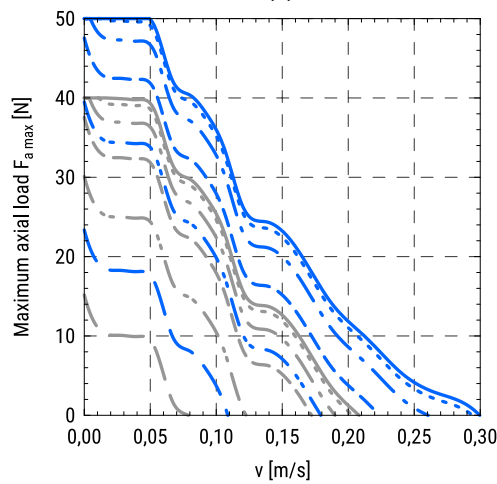

MGBS in combination:  
 — with VK  
 - - - with MSD

Acceleration/Deceleration:  
 —  $a = 0 \text{ m/s}^2$   
 - - -  $a = 0,5 \text{ m/s}^2$   
 - · -  $a = 2 \text{ m/s}^2$   
 - - -  $a = 5 \text{ m/s}^2$   
 - · -  $a = 10 \text{ m/s}^2$   
 - - -  $a = 20 \text{ m/s}^2$

## MGBS 32

8 × 2 with a stepper motor □42

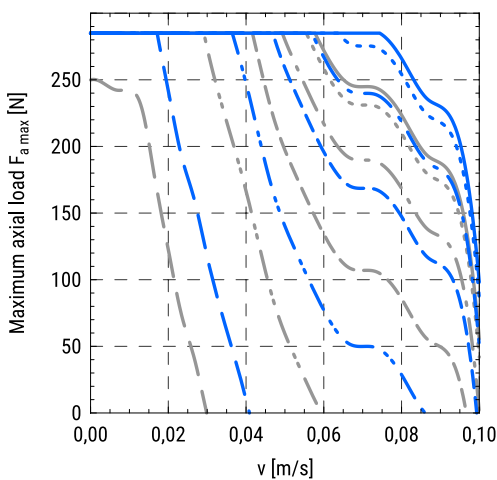

8 × 8 with a stepper motor □42

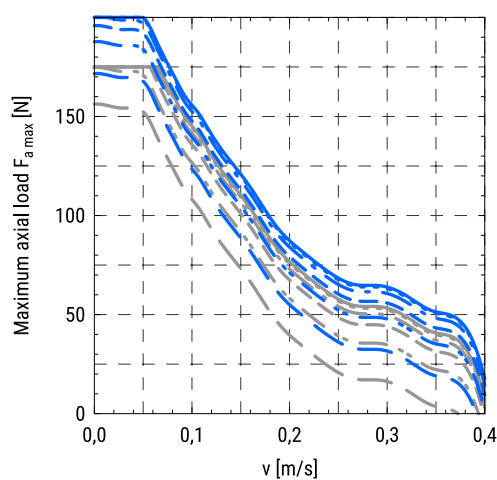

MGBS in combination:  
 — with VK  
 - - - with MSD

Acceleration/Deceleration:  
 —  $a = 0 \text{ m/s}^2$   
 - - -  $a = 0,5 \text{ m/s}^2$   
 - · -  $a = 2 \text{ m/s}^2$   
 - - -  $a = 5 \text{ m/s}^2$   
 - · -  $a = 10 \text{ m/s}^2$   
 - - -  $a = 20 \text{ m/s}^2$

**MGBS 45**

10 × 3 with a stepper motor □42

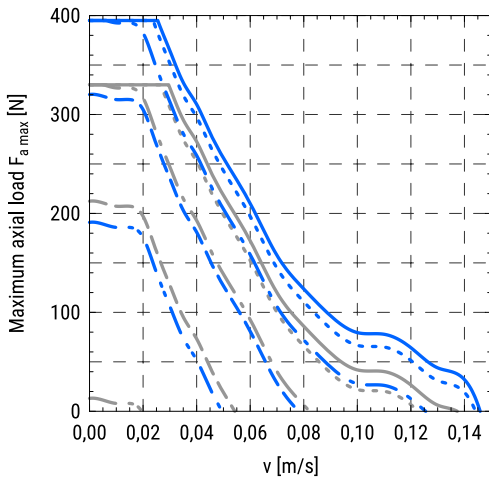

10 × 10 with a stepper motor □42

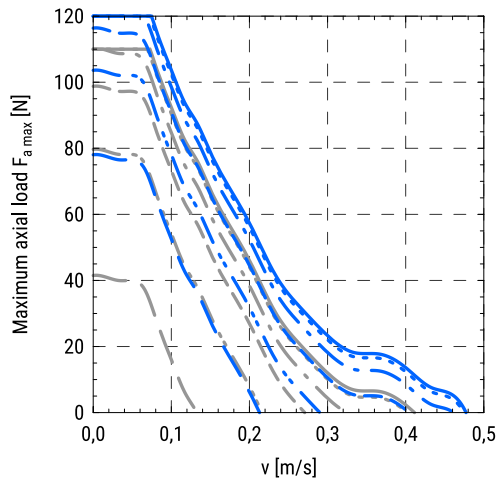

- MGBS in combination:
- with VK
  - with MSD
- Acceleration/Deceleration:
- a = 0 m/s<sup>2</sup>
  - - - a = 0,5 m/s<sup>2</sup>
  - · - a = 2 m/s<sup>2</sup>
  - - - a = 5 m/s<sup>2</sup>
  - · - a = 10 m/s<sup>2</sup>
  - a = 20 m/s<sup>2</sup>

**MGBS 45**

10 × 3 with a stepper motor □56

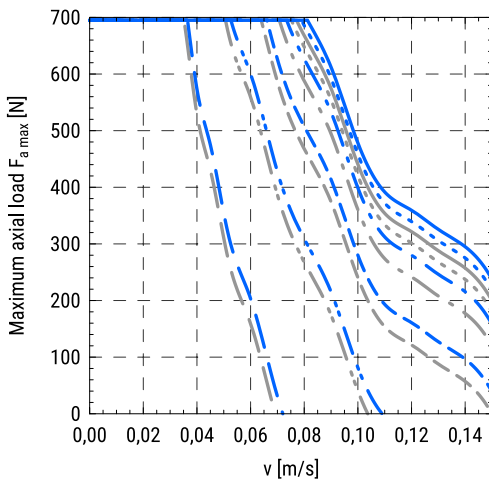

10 × 10 with a stepper motor □56

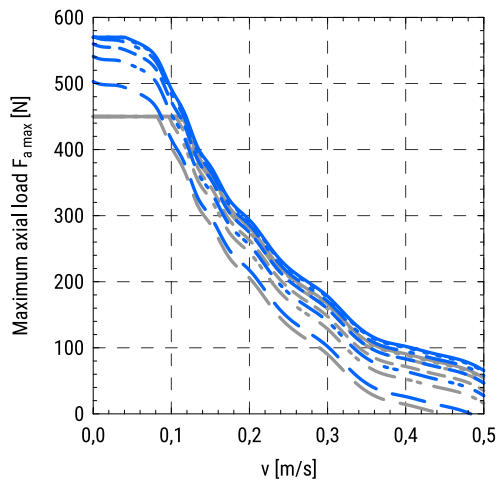

- MGBS in combination:
- with VK
  - with MSD
- Acceleration/Deceleration:
- a = 0 m/s<sup>2</sup>
  - - - a = 0,5 m/s<sup>2</sup>
  - · - a = 2 m/s<sup>2</sup>
  - - - a = 5 m/s<sup>2</sup>
  - · - a = 10 m/s<sup>2</sup>
  - a = 20 m/s<sup>2</sup>

**MGBS 60**

12 × 5 with a stepper motor □56

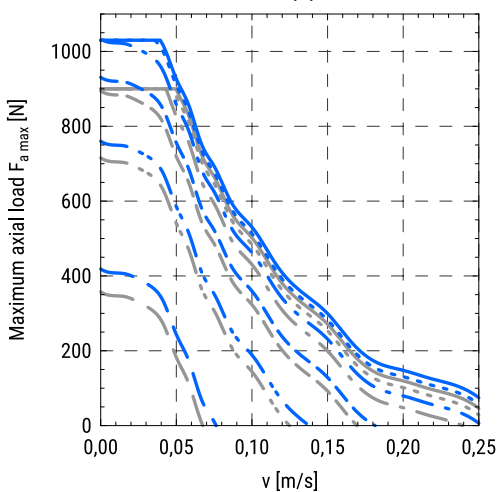

12 × 10 with a stepper motor □56

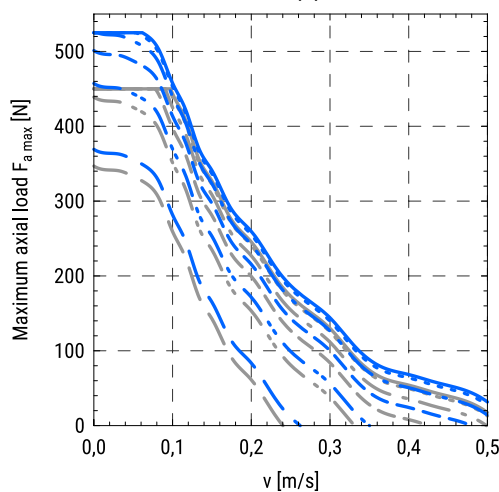

- MGBS in combination:
- with VK
  - with MSD
- Acceleration/Deceleration:
- a = 0 m/s<sup>2</sup>
  - - - a = 0,5 m/s<sup>2</sup>
  - · - a = 2 m/s<sup>2</sup>
  - - - a = 5 m/s<sup>2</sup>
  - · - a = 10 m/s<sup>2</sup>
  - a = 20 m/s<sup>2</sup>

## Maximum horizontal payload as a function of position change and positioning time of the carriage

The following diagrams show the maximum payload that can be moved by a certain horizontal distance within a positioning time frame. Acceleration/deceleration time of 100 ms is taken into account.

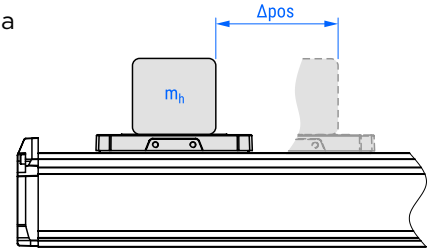

Diagrams depend on the ball screw leads and different combinations of the standard motors. Motor adapter VK and a motor side drive MSD are also considered

The diagrams shown below are valid for the linear units with an absolute stroke of 500 mm. Limitations regarding travel speed and axial loads in respect of absolute stroke are not considered and should be taken into account separately.

### MGBS 32

8 × 2 with a stepper motor □28

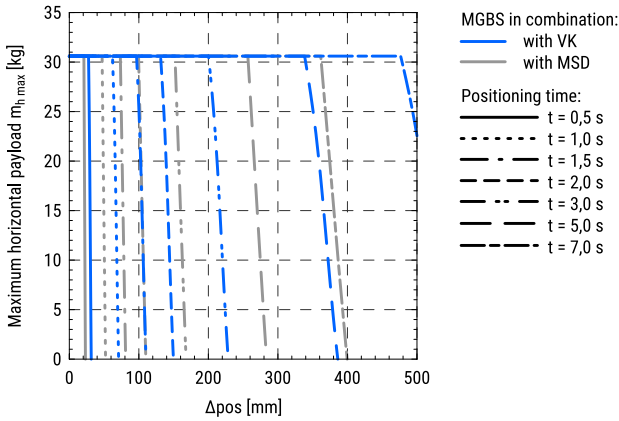

8 × 8 with a stepper motor □28

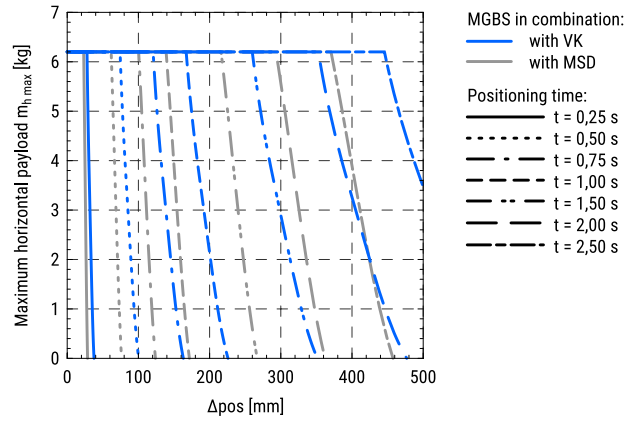

### MGBS 32

8 × 2 with a stepper motor □42

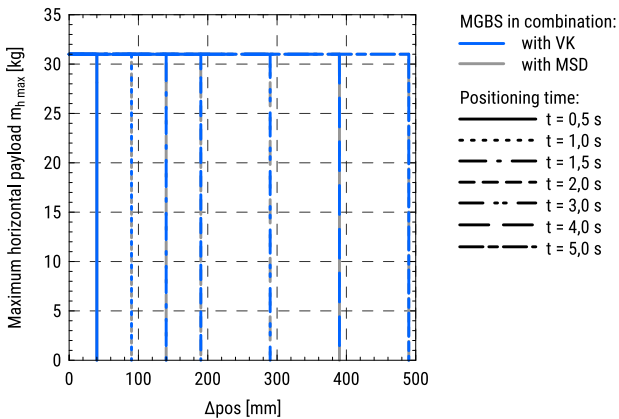

8 × 8 with a stepper motor □42

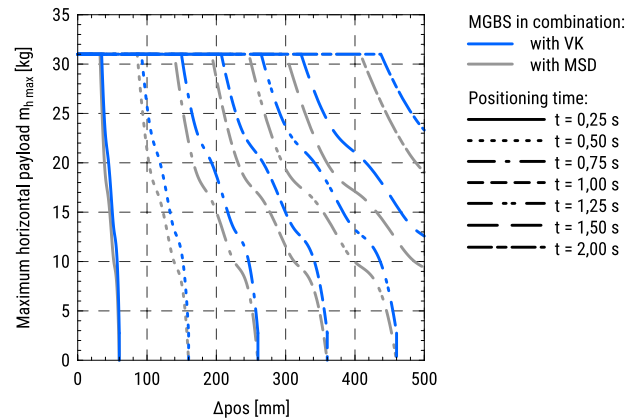

**MGBS 45**

10 × 3 with a stepper motor □42

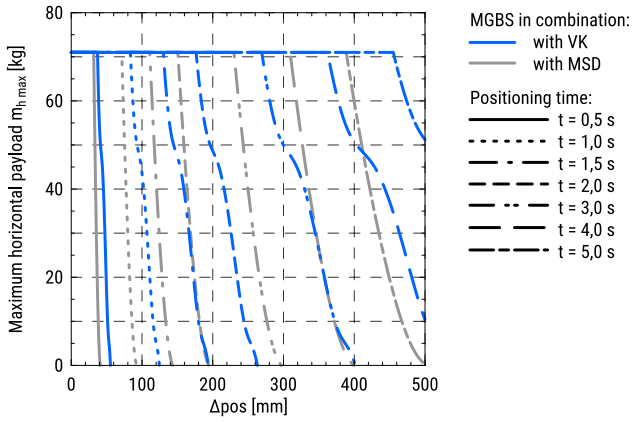

10 × 10 with a stepper motor □42

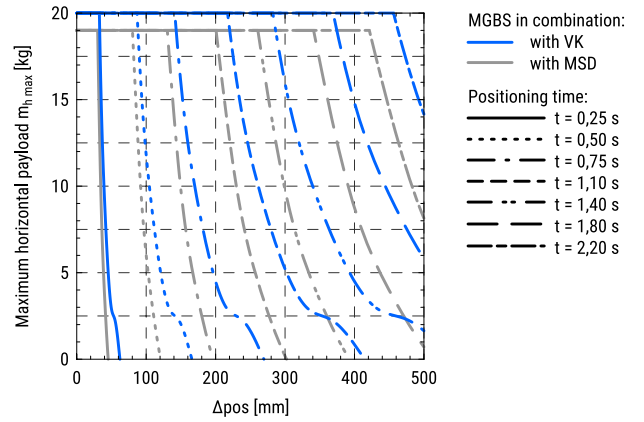

**MGBS 45**

10 × 3 with a stepper motor □56

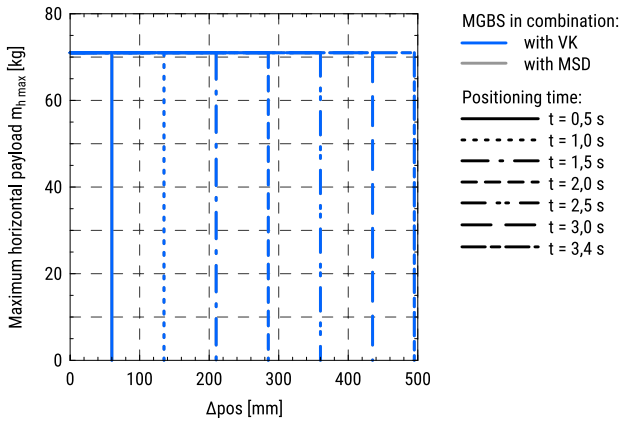

10 × 10 with a stepper motor □56

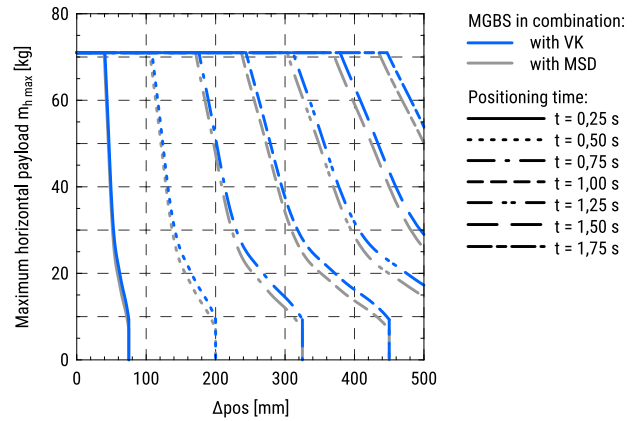

**MGBS 60**

12 × 5 with a stepper motor □56

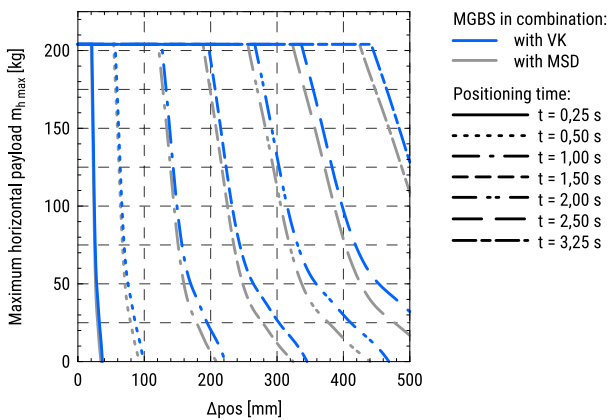

12 × 10 with a stepper motor □56

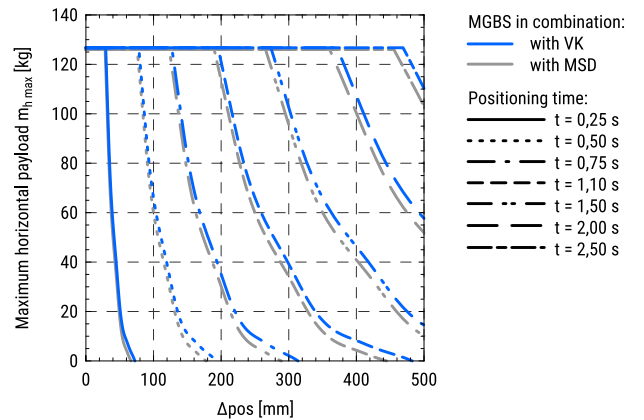

## Maximum vertical payload as a function of position change and positioning time of the carriage

The following diagrams show the maximum payload that can be moved by a certain vertical distance in a positioning time frame. Acceleration/deceleration time of 100 ms is taken into account.

Diagrams depend on the ball screw leads and combinations of standard motors. Motor adapter VK and a motor side drive MSD are also considered.

The diagrams shown below are valid for the linear units with an absolute stroke of 500 mm. Limitations regarding travel speed and axial loads in respect of absolute stroke are not considered and should be taken into account separately.

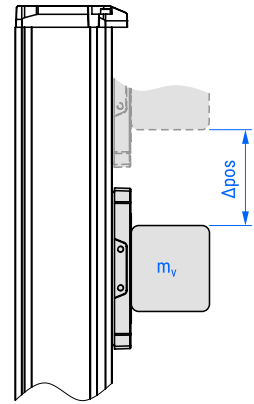

### MGBS 32

8 × 2 with a stepper motor □28

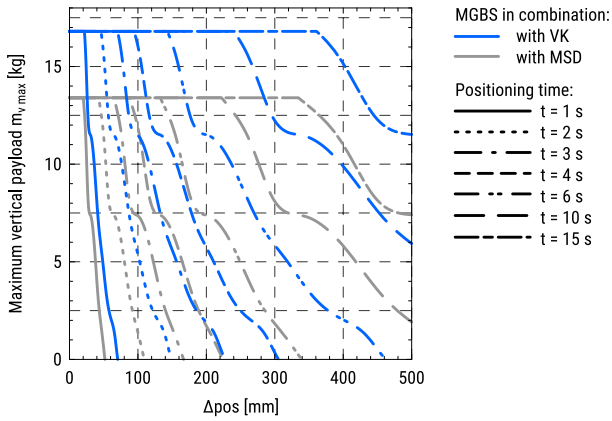

8 × 8 with a stepper motor □28

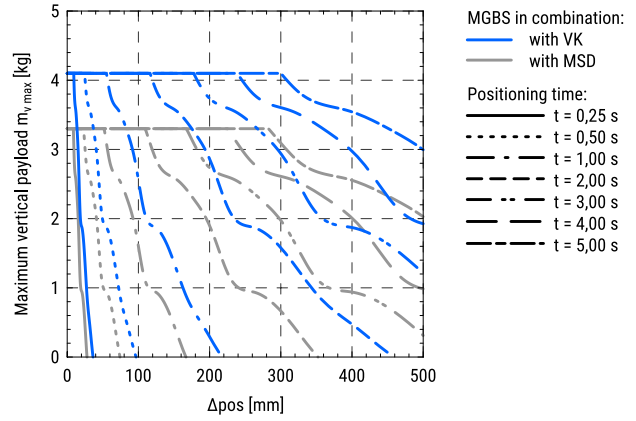

### MGBS 32

8 × 2 with a stepper motor □42

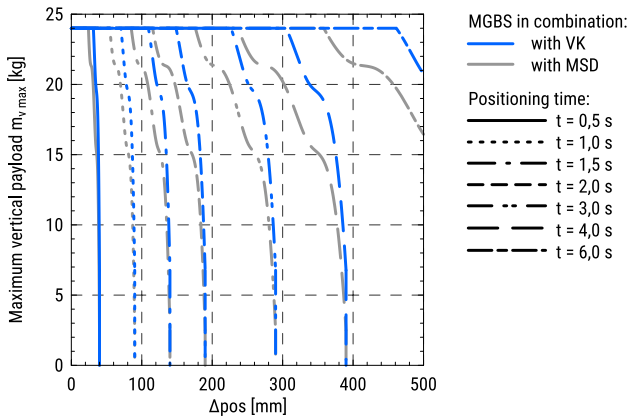

8 × 8 with a stepper motor □42

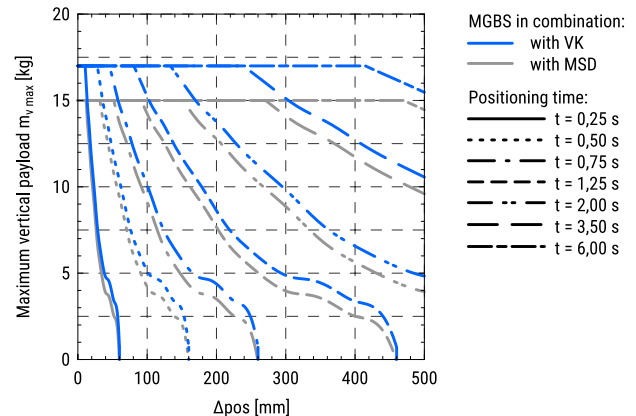

**MGBS 45**

10 × 3 with a stepper motor □42

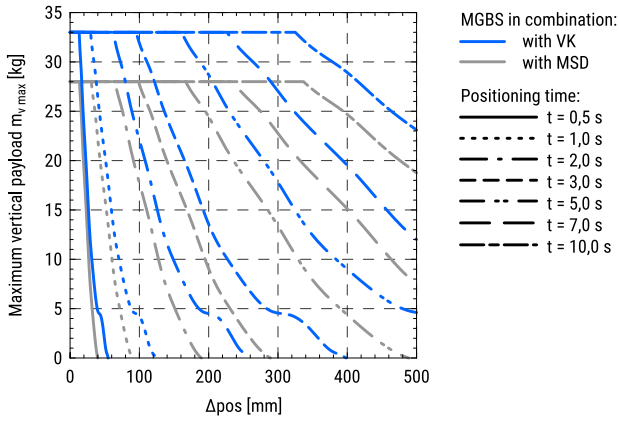

10 × 10 with a stepper motor □42

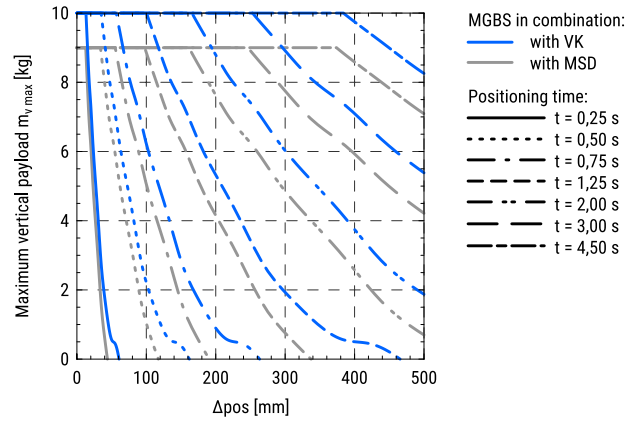

**MGBS 45**

10 × 3 with a stepper motor □56

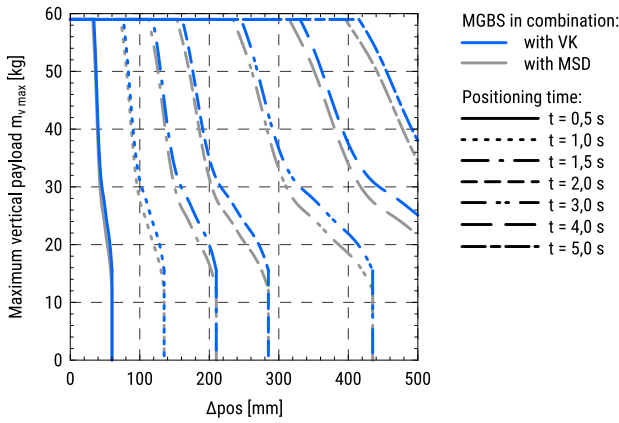

10 × 10 with a stepper motor □56

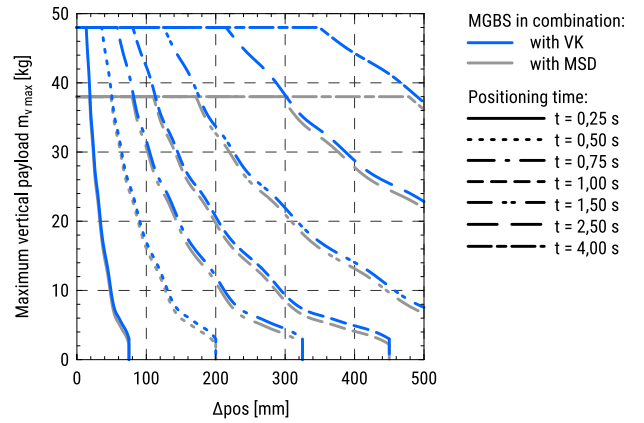

**MGBS 60**

12 × 5 with a stepper motor □56

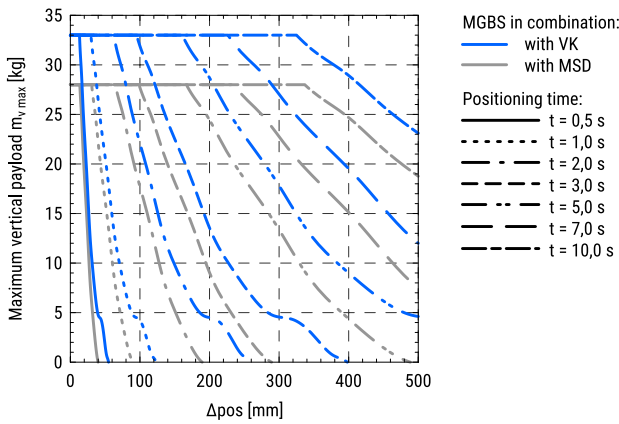

12 × 10 with a stepper motor □56

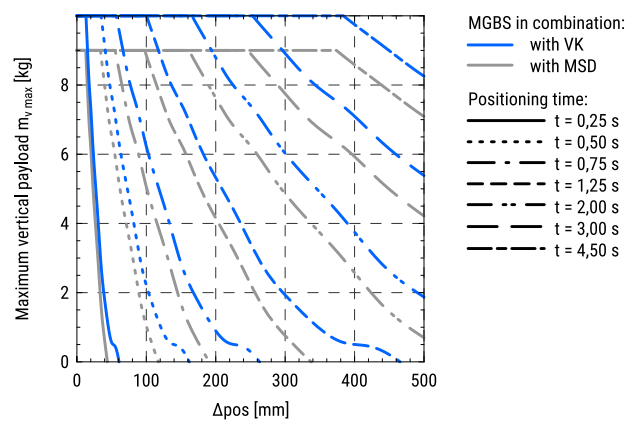

# MGTB

## Operating conditions

Ambient temperature	0 °C ~ +50 °C
Ambient temperature without a motor	0 °C ~ +60 °C
Protection class	IP40
Duty cycle	100 %
Maintenance	Life-time pre-lubricated

## Deflection of the linear unit as a function of a vertical force and the unsupported profile length

In the following diagrams, the deflection of the linear unit as a function of a vertical force and unsupported profile length is presented. For the case of both ends of the profile are supported and for the case of a console mounting the left and the right diagrams below should be considered, respectively.

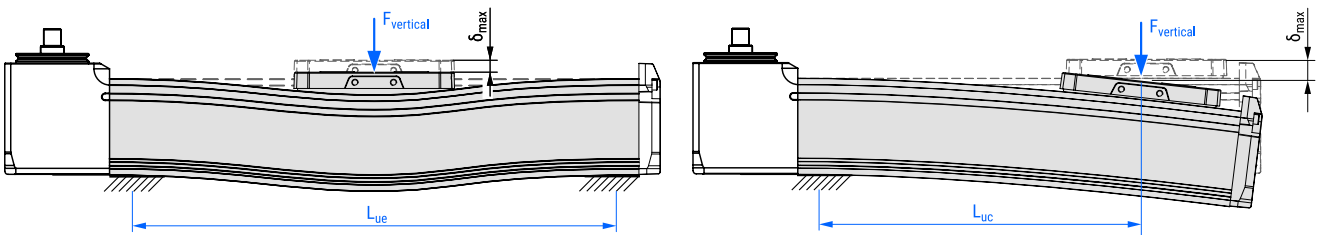

**MGTB 32**

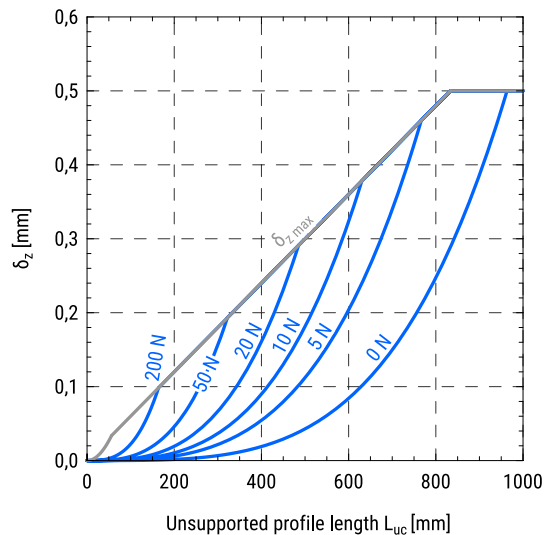
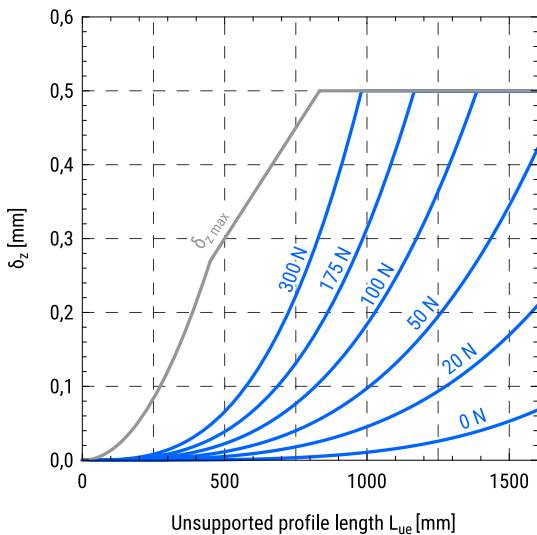



**MGTB 45**

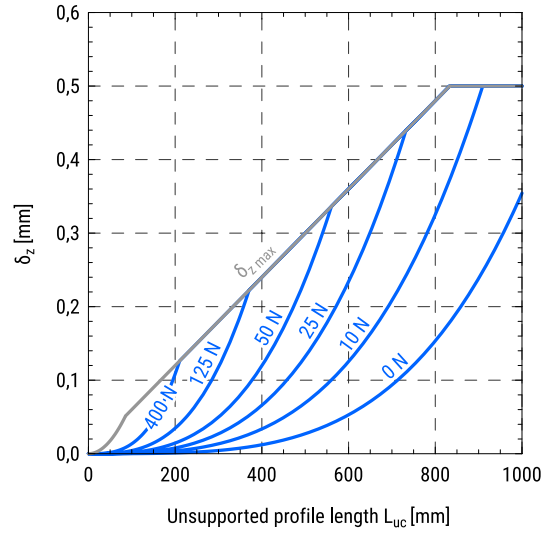
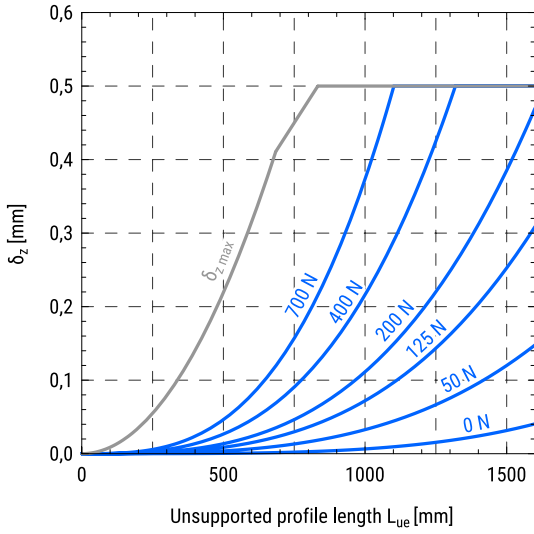

**MGTB 60**

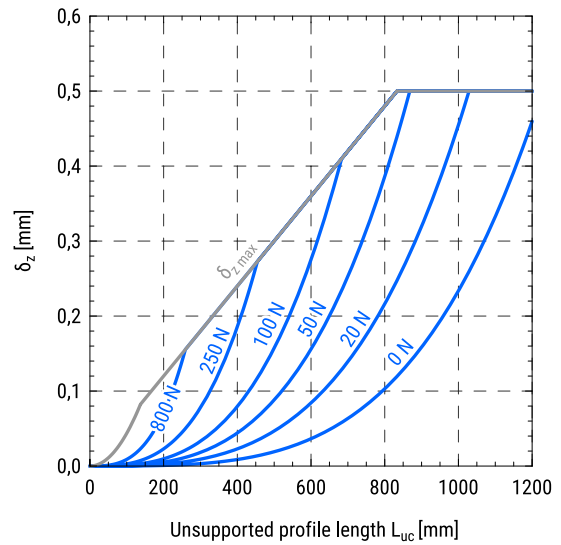
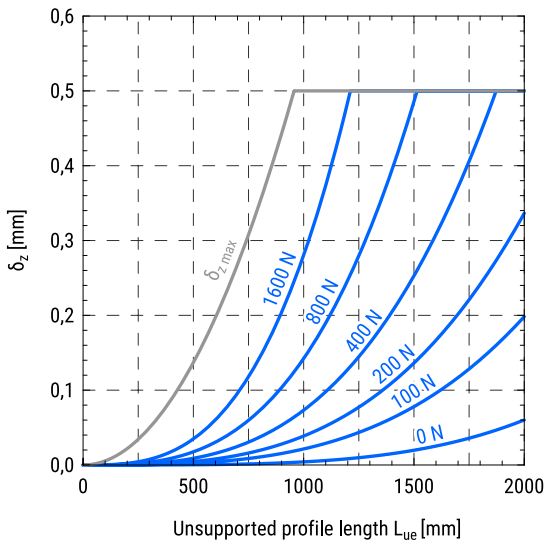

## Deformation of the toothed belt under an axial load

In the following diagram, the maximal toothed belt elongation in respect of the absolute stroke and a given axial load is presented.

The maximum belt elongation  $\delta_{\text{belt, max}}$  is proportionally changed in accordance with the ratio between the actual axial load  $F_a$  and the specific axial load given in the diagram for the particular size of the linear unit MGTB.

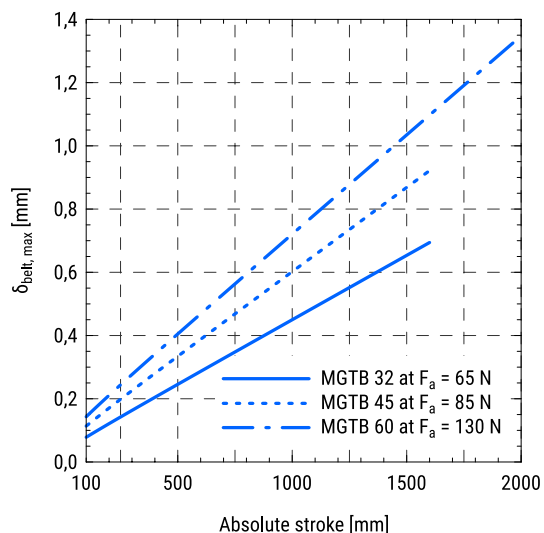
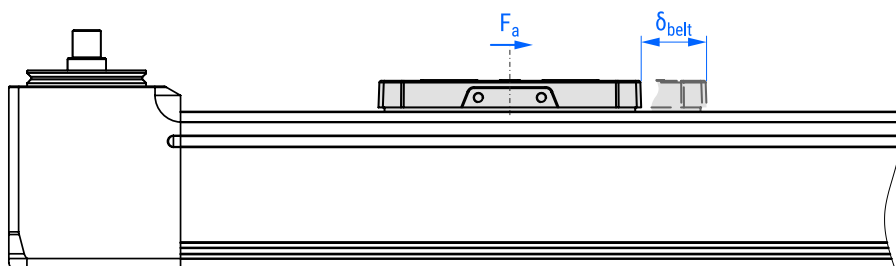

## Maximum horizontal payload as a function of the travel speed and acceleration of the carriage

In the following diagrams, maximum horizontal payloads applied to the carriage as a function of the travel speed for different accelerations and different combinations of the standard motors are presented. Motor adapter VK is considered. The diagrams shown below are valid for the linear units with an absolute stroke of 500 mm.

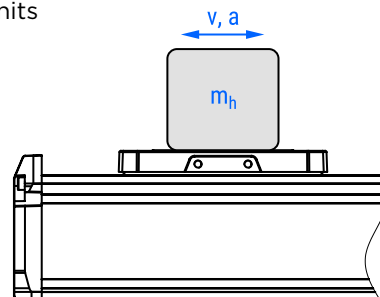

### MGTB 32

With a stepper motor □42

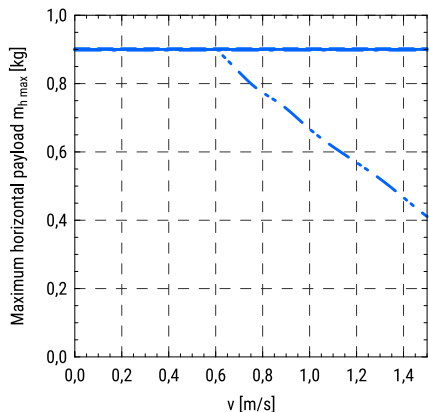

- MGTB in combination:  
 — with VK
- Acceleration/Deceleration:  
 —  $a = 0,5 \text{ m/s}^2$   
 - - -  $a = 2 \text{ m/s}^2$   
 - · -  $a = 5 \text{ m/s}^2$   
 - - -  $a = 10 \text{ m/s}^2$   
 - · -  $a = 20 \text{ m/s}^2$

### MGTB 45

With a stepper motor □42

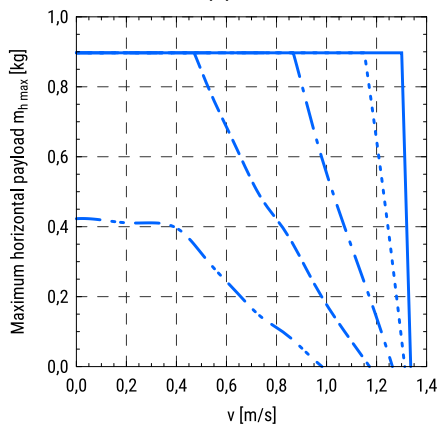

With a stepper motor □56

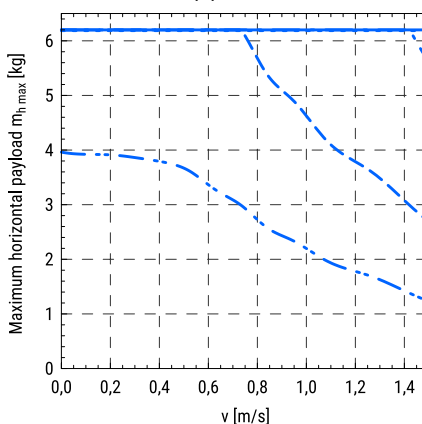

- MGTB in combination:  
 — with VK
- Acceleration/Deceleration:  
 —  $a = 0,5 \text{ m/s}^2$   
 - - -  $a = 2 \text{ m/s}^2$   
 - · -  $a = 5 \text{ m/s}^2$   
 - - -  $a = 10 \text{ m/s}^2$   
 - · -  $a = 20 \text{ m/s}^2$

### MGTB 60

With a stepper motor □56

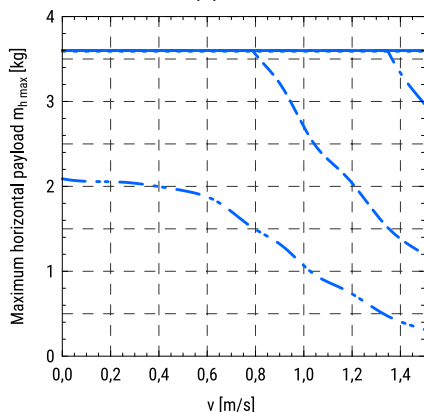

- MGTB in combination:  
 — with VK
- Acceleration/Deceleration:  
 —  $a = 0,5 \text{ m/s}^2$   
 - - -  $a = 2 \text{ m/s}^2$   
 - · -  $a = 5 \text{ m/s}^2$   
 - - -  $a = 10 \text{ m/s}^2$   
 - · -  $a = 20 \text{ m/s}^2$

# Maximum vertical payload as a function of the travel speed and acceleration of the carriage

In the following diagrams, the maximum vertical payloads applied to the carriage as a function of the travel speed for different accelerations and different combinations of the standard motors are presented. Motor adapter VK is considered. The diagrams shown below are valid for the linear units with an absolute stroke of 500 mm.

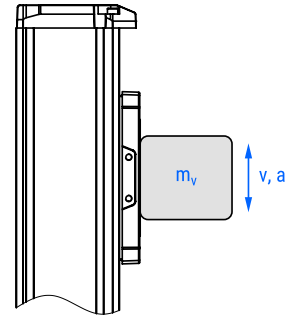

## MGTB 32

With a stepper motor □42

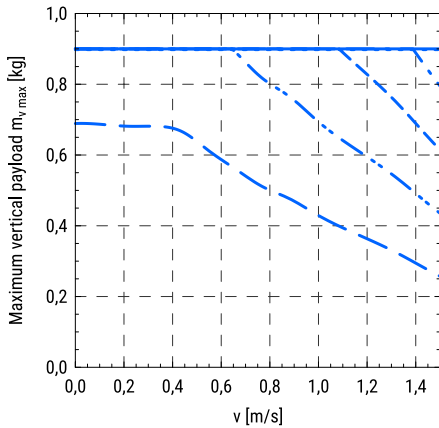

## MGTB 45

With a stepper motor □42

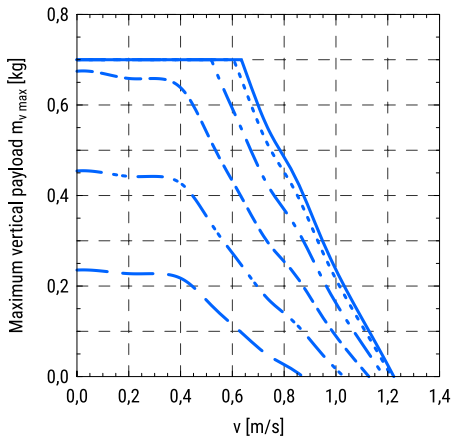

With a stepper motor □56

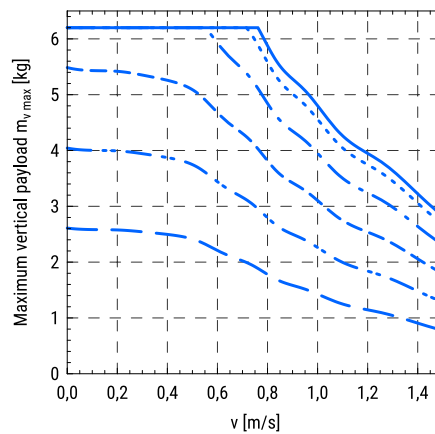

## MGTB 60

With a stepper motor □56

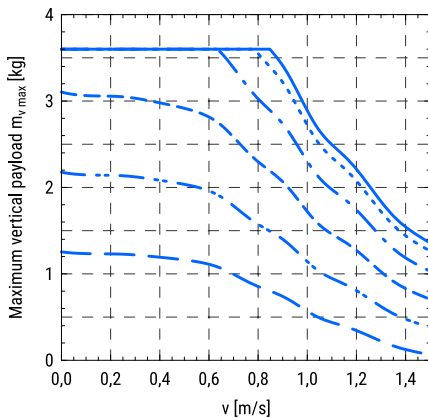

## Maximum axial load as a function of the travel speed and acceleration of the carriage

In the following diagrams, the maximum axial load applied to the carriage as a function of the travel speed for different accelerations and different combinations of the standard motors is presented. Motor adapter VK is considered. The diagrams shown below are valid for the linear units with an absolute stroke of 500 mm.

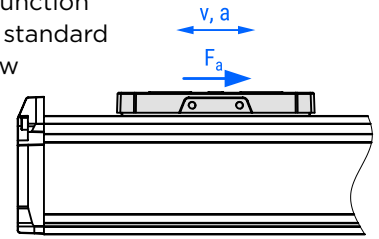

### MGTB 32

With a stepper motor □42

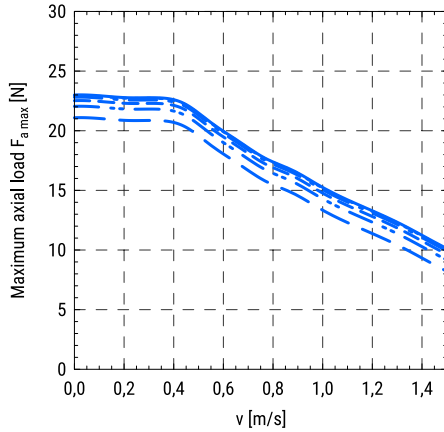

- MGTB in combination:  
 — with VK
- Acceleration/Deceleration:  
 —  $a = 0\ m/s^2$   
 - - -  $a = 0,5\ m/s^2$   
 - - - -  $a = 2\ m/s^2$   
 - - - - -  $a = 5\ m/s^2$   
 - - - - - -  $a = 10\ m/s^2$   
 - - - - - - -  $a = 20\ m/s^2$

### MGTB 45

With a stepper motor □42

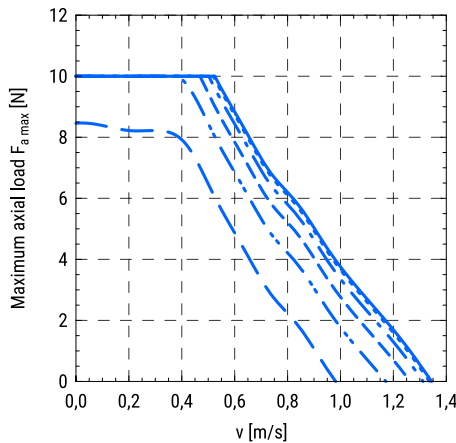

With a stepper motor □56

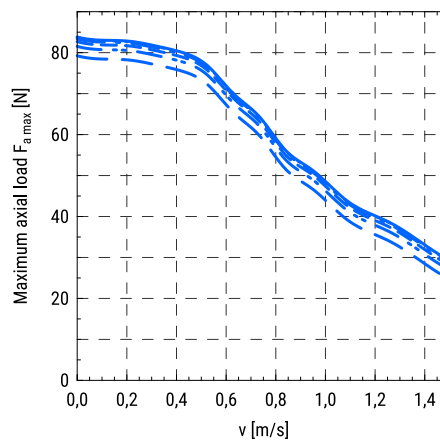

- MGTB in combination:  
 — with VK
- Acceleration/Deceleration:  
 —  $a = 0\ m/s^2$   
 - - -  $a = 0,5\ m/s^2$   
 - - - -  $a = 2\ m/s^2$   
 - - - - -  $a = 5\ m/s^2$   
 - - - - - -  $a = 10\ m/s^2$   
 - - - - - - -  $a = 20\ m/s^2$

### MGTB 60

With a stepper motor □56

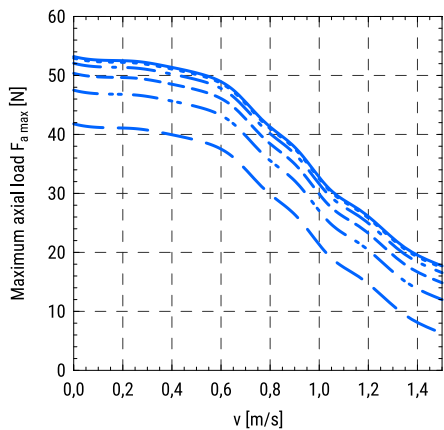

- MGTB in combination:  
 — with VK
- Acceleration/Deceleration:  
 —  $a = 0\ m/s^2$   
 - - -  $a = 0,5\ m/s^2$   
 - - - -  $a = 2\ m/s^2$   
 - - - - -  $a = 5\ m/s^2$   
 - - - - - -  $a = 10\ m/s^2$   
 - - - - - - -  $a = 20\ m/s^2$

# Maximum horizontal payload as a function of position change and positioning time of the carriage

The following diagrams show the maximum payload that can be moved by a certain horizontal distance within a positioning time frame. Acceleration/deceleration time of 100 ms is taken into account. Diagrams depend on different combinations of the standard motors. Motor adapter VK is considered. The diagrams shown below are valid for the linear units with an absolute stroke of 500 mm.

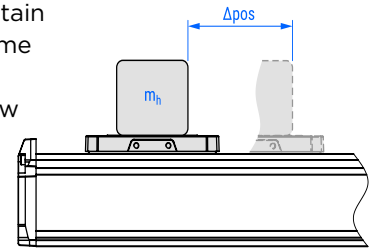

## MGTB 32

With a stepper motor □42

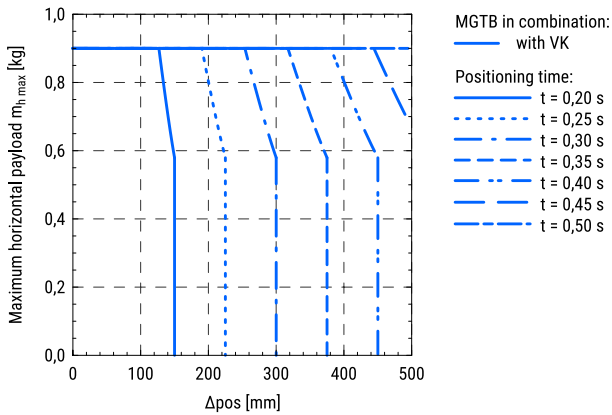

## MGTB 45

With a stepper motor □42

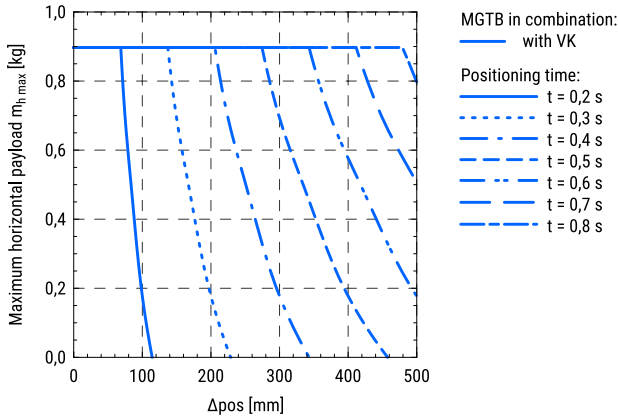

With a stepper motor □56

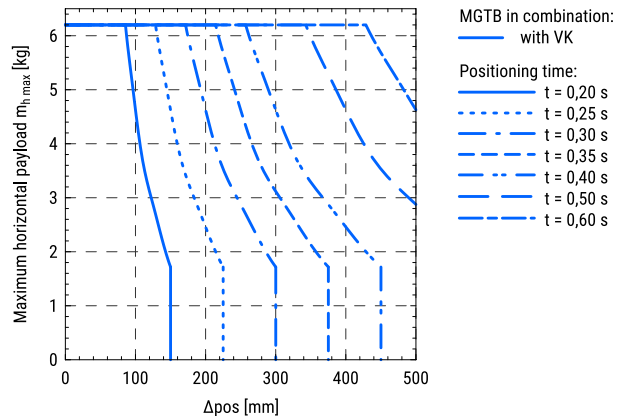

## MGTB 60

With a stepper motor □56

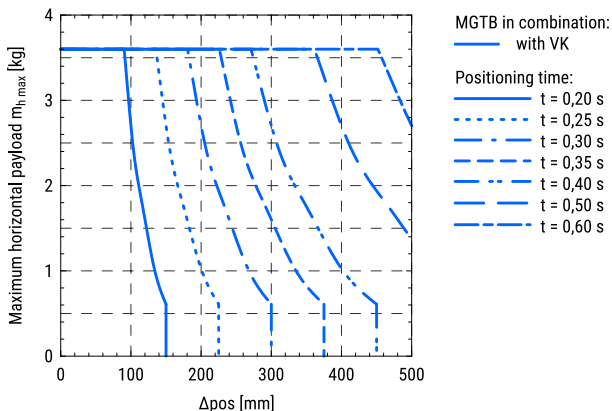

## Maximum vertical payload as a function of position change and positioning time of the carriage

The following diagrams show the maximum payload that can be moved by a certain vertical distance within a positioning time frame. Acceleration/deceleration time of 100 ms is taken into account. Diagrams depend on different combinations of the standard motors. Motor adapter VK is considered. The diagrams shown below are valid for the linear units with an absolute stroke of 500 mm.

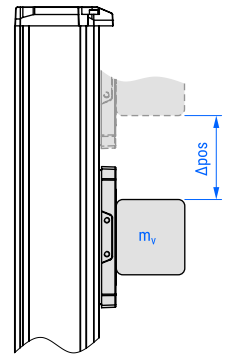

### MGTB 32

With a stepper motor □42

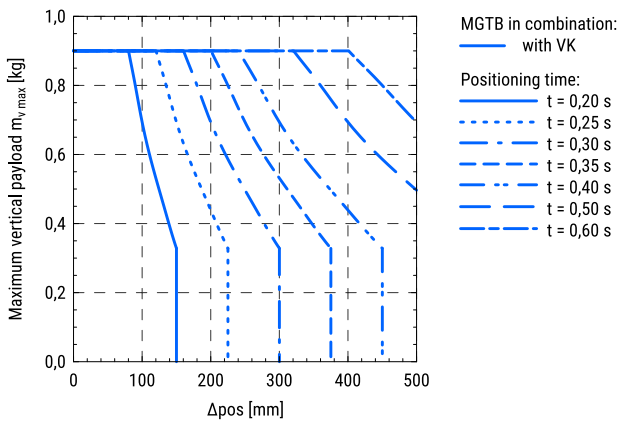

### MGTB 45

With a stepper motor □42

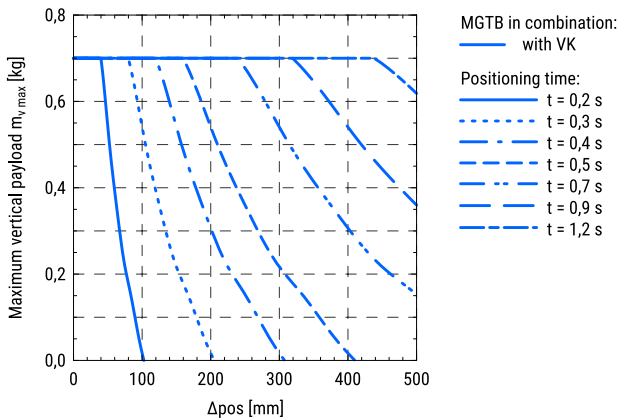

With a stepper motor □56

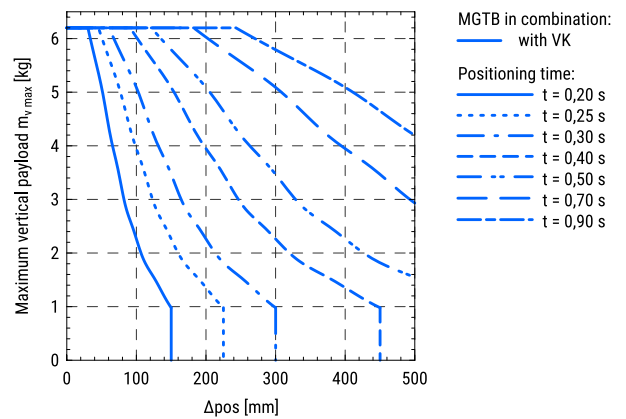

### MGTB 60

With a stepper motor □56

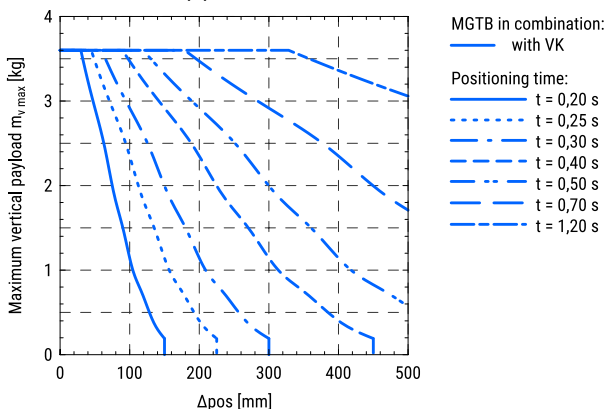

# Linear guiding

Dynamic load capacity, dynamic moments and maximum permissible loads of the linear guiding system integrated in the mini linear unit refers to the centre of the linear guides.

The applied loading condition needs to be calculated with respect to the centre of the linear guides.

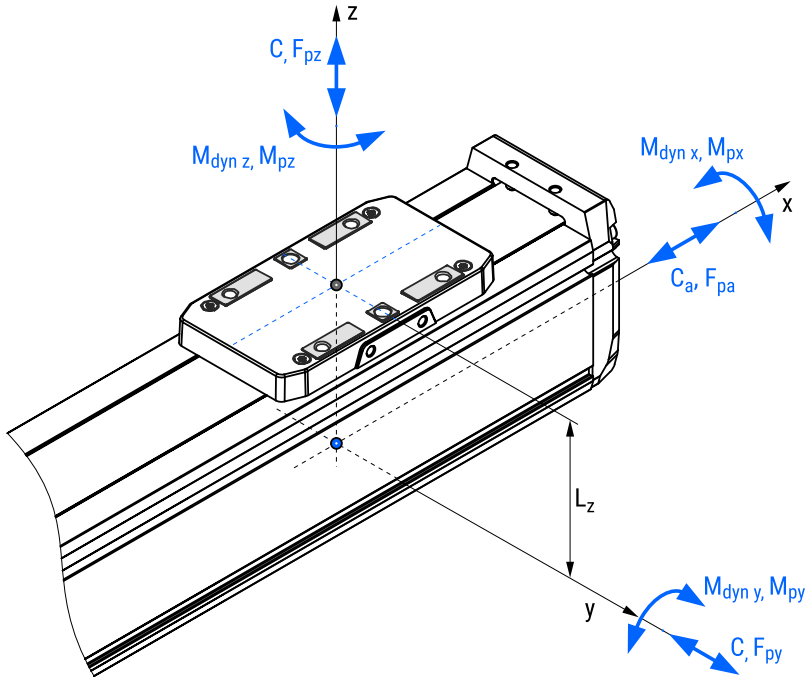

Designation	Attachment distances
	$L_z$ [mm]
MGBS/MGTB 32	30.0
MGBS/MGTB 45	40.7
MGBS/MGTB 60	54.7

<b>C</b>	Dynamic load capacity [N]
<b>M<sub>dyn x</sub></b>	Dynamic moment about the x axis [Nm]
<b>M<sub>dyn y</sub></b>	Dynamic moment about the y axis [Nm]
<b>M<sub>dyn z</sub></b>	Dynamic moment about the z axis [Nm]
<b>F<sub>py max</sub></b>	Max. permissible force in the y direction [N]
<b>F<sub>pz max</sub></b>	Max. permissible force in the z direction [N]
<b>M<sub>px max</sub></b>	Max. permissible moment about the x axis [Nm]
<b>M<sub>py max</sub></b>	Max. permissible moment about the y axis [Nm]
<b>M<sub>pz max</sub></b>	Max. permissible moment about the z axis [Nm]



## Permissible load

### Permissible load factor $f_{p,g}$

A permissible load factor of the linear guiding system  $f_{p,g}$  must never exceed the value of 1.

$$f_{p,g} = \frac{|F_y|}{F_{py}} + \frac{|F_z|}{F_{pz}} + \frac{|M_x|}{M_{px}} + \frac{|M_y|}{M_{py}} + \frac{|M_z|}{M_{pz}} \leq 1$$

$f_{p,g}$	Permissible load factor
$F_y$	Applied force in the y direction [N]
$F_z$	Applied force in the z direction [N]
$M_x$	Applied moment about the x axis [Nm]
$M_y$	Applied moment about the y axis [Nm]
$M_z$	Applied moment about the z axis [Nm]

## Service life

### Service life calculation

$$L_{km,g} = \left( \frac{1}{f_{vm,g}} \right)^3 \cdot 10^2$$

$L_{km,g}$	Service life of the linear guiding system [km]
$f_{vm,g}$	Mean load comparison factor

### Mean load comparison factor $f_{vm,g}$ as a function of service life $L_{km,g}$

The diagram represents the theoretically determined service life of the linear guiding system when the mean load comparison factor  $f_{vm,g}$  is considered.

It should be noted that the application conditions may have a significant effect on the service life.

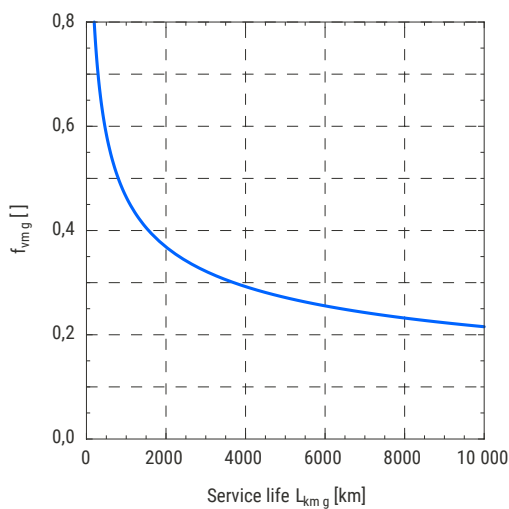

**Mean load comparison factor  $f_{vmg}$**

$$f_{vmg} = \sqrt[3]{\frac{f_{v1g}^3 \cdot S_1 + f_{v2g}^3 \cdot S_2 + \dots + f_{vng}^3 \cdot S_n}{S_1 + S_2 + \dots + S_n}}$$

$f_{vi g}$	i-th load comparison factor of a given loading regime $f_{vg}(s)$ , $i \in \{1, 2, \dots, n\}$
$S_i$	i-th travel path of a given loading regime $f_{vg}(s)$ , $i \in \{1, 2, \dots, n\}$

**Loading regime  $f_{vg}(s)$**

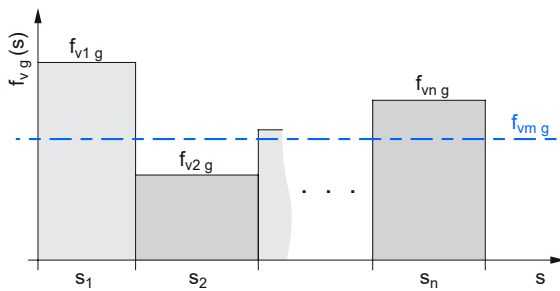

**Load comparison factor  $f_{vg}$**

$$f_{vg} = \frac{|F_y|}{C} + \frac{|F_z|}{C} + \frac{|M_x|}{M_{dyn x}} + \frac{|M_y|}{M_{dyn y}} + \frac{|M_z|}{M_{dyn z}}$$

$f_{vg}$	Load comparison factor
----------	------------------------

**Mean dynamic safety factor  $f_{smg}$**

The safety factor depends on the application and its requested safety. A minimum dynamic safety factor of 5,0 or more is recommended.

$$f_{smg} = \frac{1}{f_{vmg}}$$

$f_{smg}$	Mean dynamic safety factor
-----------	----------------------------

## Ball screw drive

Valid for the mini linear unit MGBS.

### Permissible load

**Permissible load factor  $f_{pbs}$**

A permissible load factor of the ball screw drive  $f_{pbs}$  must never exceed the value of 1.

$$f_{p\ bs} = \frac{|F_x|}{F_{pa}} \leq 1$$

$f_{p\ bs}$	Permissible load factor
$F_{pa}$	Max. permissible axial load [N]
$F_x$	Applied force in the x direction [N]

## Service life

### Service life calculation

$$L_{km\ bs} = \left(\frac{1}{f_{vm\ bs}}\right)^3 \cdot l$$

$L_{km\ bs}$	Service life [km]
$f_{vm\ bs}$	Mean load comparison factor
$l$	Ball screw lead [mm]

### Mean load comparison factor $f_{vm\ bs}$ as a function of service life $L_{km\ bs}$

The diagram represents the theoretically determined service life of the ball screw drive when the mean load comparison factor  $f_{vm\ bs}$  is considered.

It should be noted that the application conditions may have a significant effect on the service life.

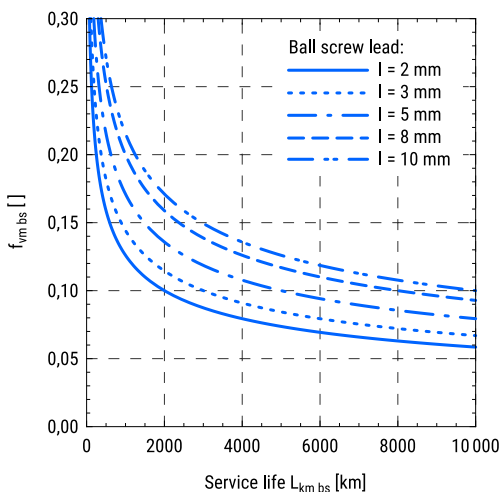

### Mean load comparison factor $f_{vm\ bs}$

$$f_{vm\ bs} = \sqrt[3]{\frac{f_{v1\ bs}^3 \cdot s_1 + f_{v2\ bs}^3 \cdot s_2 + \dots + f_{vn\ bs}^3 \cdot s_n}{s_1 + s_2 + \dots + s_n}}$$

$f_{vi\ bs}$	i-th load comparison factor of a given loading regime $f_{v\ bs}(s)$ , $i \in \{1, 2, \dots, n\}$
$s_i$	i-th travel path of a given loading regime $f_{v\ bs}(s)$ , $i \in \{1, 2, \dots, n\}$

**Loading regime  $f_{v\ bs}$  (s)**

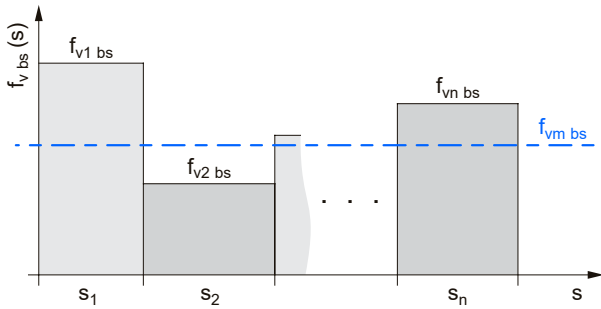

**Load comparison factor  $f_{v\ bs}$**

$$f_{v\ bs} = \frac{|F_x|}{C_a}$$

$f_{v\ bs}$	Load comparison factor
$C_a$	Dynamic axial load capacity [N]

**Mean dynamic safety factor  $f_{sm\ bs}$**

The safety factor depends on the application and its requested safety. A minimum dynamic safety factor of 5,0 or more is recommended.

$$f_{sm\ bs} = \frac{1}{f_{vm\ bs}}$$

$f_{sm\ bs}$	Mean dynamic safety factor
--------------	----------------------------

**Mini linear unit MGBS**

Service life of the mini linear unit is the minimum value between the calculated service life of the linear guiding system  $L_{km\ g}$  and the ball screw drive  $L_{km\ bs}$ .

$$L_{km} = \text{Min}[L_{km\ g}, L_{km\ bs}]$$

$L_{km}$	Service life of the mini electric cylinder or slider [km]
----------	---

**Mini linear unit MGTB**

Service life of the mini linear unit is the same as the calculated service life of the linear guiding system  $L_{km\ g}$ .

$$L_{km} = L_{km\ g}$$

$L_{km}$	Service life of the mini electric cylinder or slider [km]
----------	---

# Calculations

## Load torque

The load torque is a function of an applied axial load (force) to the mini linear unit MGBS/MGTB and can be calculated as follows:

$$M_{load} = \frac{F_x \cdot l}{2000 \cdot \pi \cdot \eta}$$

$M_{load}$	Load torque [Nm]
$F_x$	Applied axial force [N]
$l$	Ball screw lead <sup>1</sup> [mm]
	Pulley-drive ratio <sup>2</sup> [mm/rev]
$\eta$	Mechanical efficiency $\approx 0,9^1$
	Mechanical efficiency $\approx 1,0^2$

<sup>1</sup> Valid for the mini linear unit MGBS.

<sup>2</sup> Valid for the mini linear unit MGTB.

It should be noted that the load torque  $M_{load}$  must never exceed the maximum drive torque  $M_p$  (or  $M_{p, MSD}$  if a motor side drive MSD is taken into consideration).

# MGBS

MGBS - 32 - 0802 - 200 - AB - AU - AA - AB - AA

**Series:**  
MGBS

**Size:**  
- 32  
- 45  
- 60

**Ball screw size:**  
- MGBS 32:  $\varnothing 8 \times 2, \varnothing 8 \times 8$   
- MGBS 45:  $\varnothing 10 \times 3, \varnothing 10 \times 10$   
- MGBS 60:  $\varnothing 12 \times 5, \varnothing 12 \times 10$

**Absolute stroke [mm]:**  
(Absolute stroke = Effective stroke + 2 × Safety stroke)  
- 50, 100, 150, 200, 250, 300, 400, 500, 600, 700, 800 (900, 1000 for MGBS 60 only)

**Motor type and size:**  
- Leave blank: Without a motor

A B

**Motor type:**  
- A: Stepper motor without a brake  
- B: Stepper motor with a brake

**Motor size □:**  
- A: 28 mm (Currently not available)  
- B: 42 mm  
- C: 56 mm  
- D: 86 mm (Currently not available)

**Available sizes:**  
- MGBS 32: 28, 42  
- MGBS 45: 42, 56  
- MGBS 60: 56, 86

**Motor mounting option:**

- Leave blank: Without a motor

**Mounting option:**

- A: With a motor adapter VK
- B: With a motor side drive MSD facing up
- C: With a motor side drive MSD facing right
- D: With a motor side drive MSD facing down
- E: With a motor side drive MSD facing left

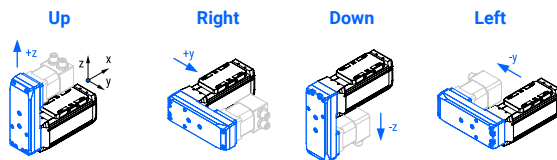

**Direction of the motor connectors:**

- U: Connectors facing up
- R: Connectors facing right
- D: Connectors facing down
- L: Connectors facing left

**In combination with a motor adapter VK**

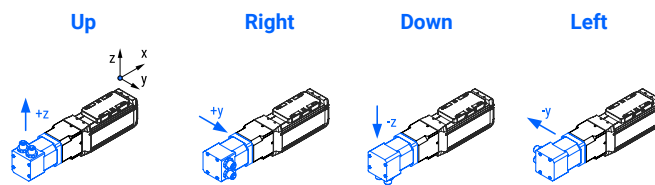

**In combination with a motor side drive MSD**

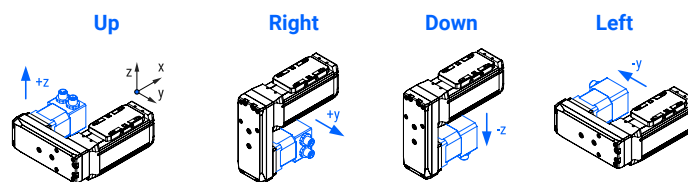

When using the motor side drive MSD, the connectors can not be facing the MGBS otherwise, the connectors and MGBS may collide. These combinations are: BD, CL, DU and ER.

**Drive option:**

- Leave blank: Without a motor or drive

**Drive type:**

- A: Stepper

A

A

**Drive protocol/control:**

- A: EtherCAT
- B: Ethernet based communication
- C: Pulse-direction control
- D: Profinet

**Drive-motor cables option:**

- Leave blank: Without a motor or drive
- 00: Without the cables

**Cables type:**

- A: Robotic with a straight plug
- B: Robotic with an angled plug

A

B

**Cables length:**

- A: 3 m
- B: 5 m
- C: 10 m

**Power and signal cables:**

- Leave blank: Without a motor or drive

**Power cable:**

- 0: Without a power cable
- A: With a power cable

A

A

**Signal cable:**

- 0: Without a signal cable
- A: With a signal cable

# MGTB

MGTB - 45 - 500 - AB - AB - AA - AB - AA

**Series:**  
MGTB

**Size:**  
- 32  
- 45  
- 60

**Absolute stroke [mm]:**  
(Absolute stroke = Effective stroke + 2 × Safety stroke)  
- 100, 200, 300, 400, 500, 600, 700, 800, 1000, 1200, 1400, 1600  
(1800, 2000 for MGTB 60 only)

**Motor type and size:**  
- Leave blank: Without a motor

A B

**Motor type:**  
- A: Stepper motor without a brake  
- B: Stepper motor with a brake

**Motor size □:**  
- B: 42 mm  
- C: 56 mm  
- D: 86 mm (Currently not available)

**Available sizes:**  
- MGTB 32: 42  
- MGTB 45: 42, 56  
- MGTB 60: 56, 86



**Motor mounting option:**

- Leave blank: Without a motor

A

B

**Mounting option:**

- A: With a motor adapter VK

**Mounting option:**

- B: Connectors facing back
- R: Connectors facing right
- F: Connectors facing front
- L: Connectors facing left

**In combination with a motor adapter VK**

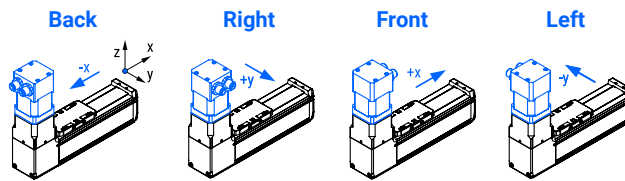

**Drive option:**

- Leave blank: Without a motor or drive

A

**Drive type:**

- A: Stepper

A

**Drive protocol/control:**

- A: EtherCAT
- B: Ethernet based communication
- C: Pulse-direction control
- D: Profinet

**Drive-motor cables option:**

- Leave blank: Without a motor or drive
- 00: Without the cables

A

**Cables type:**

- A: Robotic with a straight plug
- B: Robotic with an angled plug

B

**Cables length:**

- A: 3 m
- B: 5 m
- C: 10 m

**Power and signal cables:**

- Leave blank: Without a motor or drive

A

**Power cable:**

- O: Without a power cable
- A: With a power cable

A

**Signal cable:**

- O: Without a signal cable
- A: With a signal cable



# Couplings

COUPLING - EKL5 - A - F5 - F6PFN

**Coupling**

**Coupling type/size:**

- 2
- 5
- 10

**Elastomer insert type:**

- A

**Hole diameter**

[mm]

**Option:**

- PFN: with the keyway
- Leave blank: without the keyway

# Motor side drive MSD with a timing belt

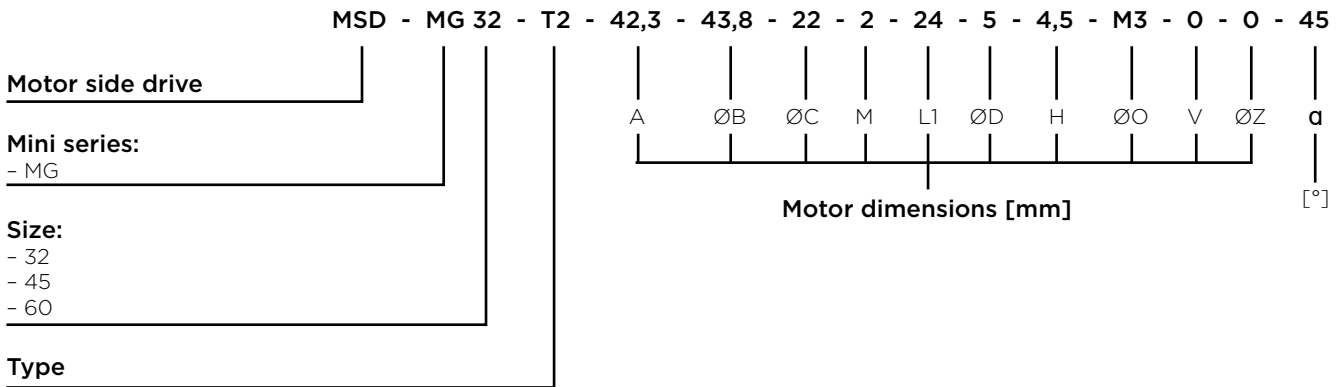

Dimension ØO is also used for tapped holes. In case of tapped holes, prefix M must be applied.

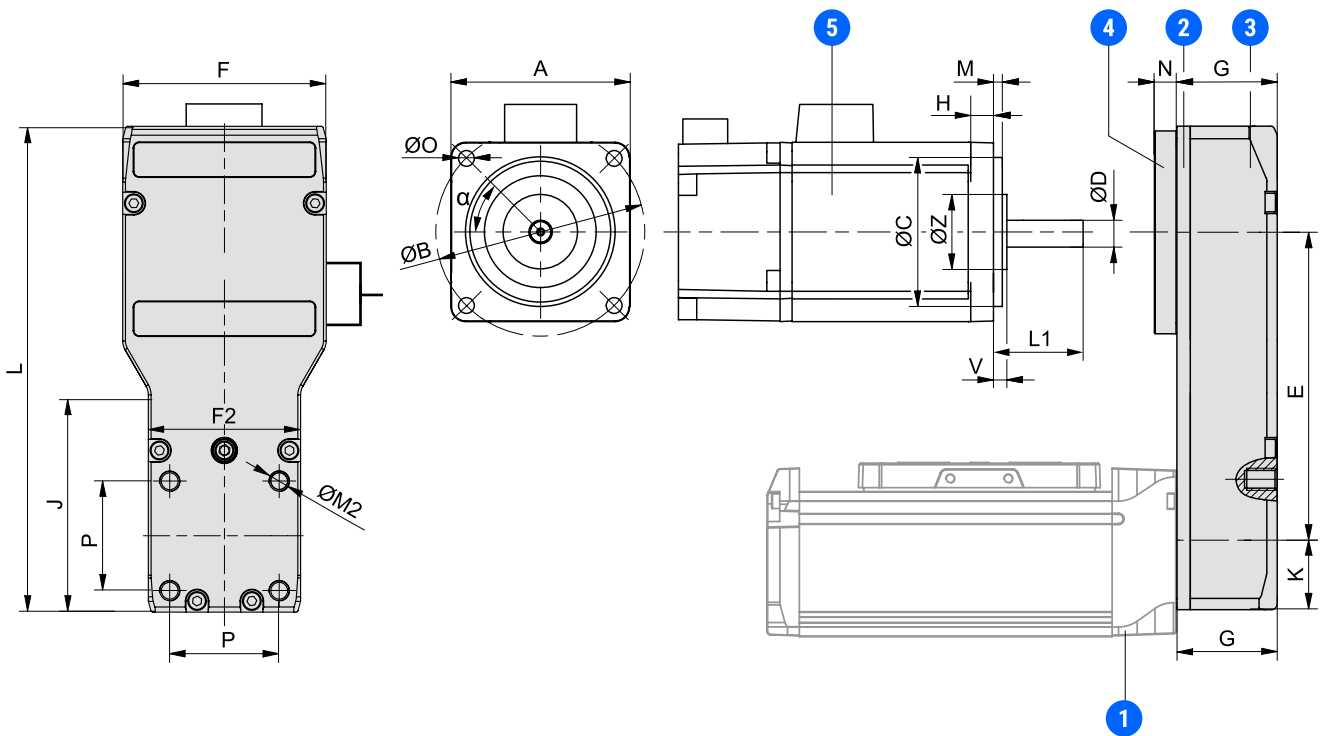

- 1 - MGBS
  - 2 - Motor side drive housing
  - 3 - Motor side drive cap
  - 4 - Motor side drive tensioning plate
  - 5 - Motor
- } Motor side drive MSD

# Motor

STMN - 42 - L - E - B

**Stepper motor series**

**Size:**

- 28 (Currently not available)
- 42
- 56
- 86 (Currently not available)

**Motor length**

- L: Long

**Encoder:**

- E: With

**Brake:**

- Leave blank: Without
- B: With

# Drive

STDF - 42 - A - EC

**Stepper drive series**

- STDF
- STDL<sup>1</sup>

**Size:**

- 28 (Currently not available)
- 42
- 56
- 86 (Currently not available)
- 040<sup>1</sup> (for motor size 42 or 56)

**Operating voltage:**

- A: 24
- B: 40-70
- C: 20-50

**Protocol/control:**

- EC: EtherCAT
- EN: Ethernet based communication
- PD: Pulse-direction control
- PN<sup>1</sup>: Profinet

<sup>1</sup> Only available with Profinet communication, oprating voltage option C and motor size option 040.

# Drive-motor cables

STCF - E - A8 - 05

**Stepper drive/motor cable series**

- STCF: for STDF drives
- STCS: for STDL drives

**Type:**

- M: Motor cable
- E: Encoder cable
- B: Brake cable

**Connector type and size:**

**Connector type:**     A     8

- S: Stepper
- A: Angled

**Connector size:**     8

- 8: M8
- 12: M12

**Cable length:**

- 03: 3 m
- 05: 5 m
- 10: 10 m

STCF - BT - 02

**Stepper drive/motor cable series**

**Type:**

- BT: Brake to terminal cable

**Cable length:**

- 02: 2 m

# Power and signal cables

STCF - P - 02

Stepper drive/motor cable series

**Type:**

- P: Power cable

**Cable length:**

- 02: 2 m

STCF - S - EC - 02

Stepper drive/motor cable series

**Type:**

- S: Signal cable

**Drive protocol/control:**

- EC: EtherCAT
- EN: Ethernet based communication
- PD: Pulse-direction control

**Cable length:**

- 02: 2 m



**ALWAYS THE RIGHT  
SOLUTION AT THE RIGHT TIME.**

**ROLLCO**

LINEAR SOLUTIONS **YOUR WAY**

With reliability, competence and commitment Rollco rapidly delivers the right solutions and components to create safe and cost-effective automation and linear movement.

**Rollco AB**

Box 22234  
Ekvändan 3  
250 24 Helsingborg  
Sweden  
Tel. +46 42 15 00 40  
[www.rollco.se](http://www.rollco.se)

**Rollco A/S**

Skomagervej 13 E  
7100 Vejle  
Denmark  
Tel. +45 75 52 26 66  
[www.rollco.dk](http://www.rollco.dk)

**Rollco Oy**

Sarankulmankatu 12  
33900 Tampere  
Finland  
Tel. +358 207 57 97 90  
[www.rollco.fi](http://www.rollco.fi)

**Rollco Norge AS**

Industrigata 6  
3414 Lierstrada  
Norway  
Tel. +47 32 84 00 34  
[www.rollco.no](http://www.rollco.no)